

# *Delray Beach*

## HISTORIC PRESERVATION DESIGN GUIDELINES

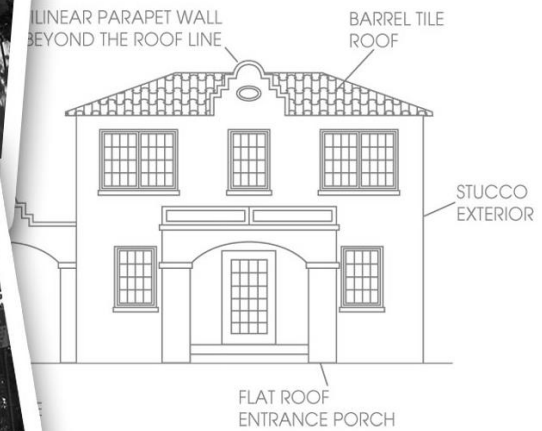

November 2018

This project has been financed in part with historic preservation grant assistance provided by the National Park Service, U.S. Department of the Interior, administered through the Bureau of Historic Preservation, Division of Historical Resources, Florida Department of State, assisted by the Florida Historical Commission. However, the contents and opinions do not necessarily reflect the views and opinions of the Department of the Interior or the Florida Department of State, nor does the mention of trade names or commercial products constitute an endorsement or recommendation by the Department of the Interior or the Florida Department of State. This program receives federal financial assistance for the identification and protection of historic properties. Under Title VI of the Civil Rights Act of 1964, Section 504 of the Rehabilitation Act of 1973, and the Age Discrimination Act of 1975, as amended, the U.S. Department of the Interior prohibits discrimination on the basis of race, color, national origin, disability, or age in its federally assisted programs. If you believe you have been discriminated against in any program, activity, or facility as described above, or if you desire further information please write to: Office of Equal Opportunity, National Park Service, 1849 C Street, NW, Washington, D.C. 20240.

### **Photographic and Illustrative Sources:**

Photographs and other images on the following pages courtesy City of Delray Beach:

Front cover, 4, 7-12, 20 (bottom left), 21 (photo), 23 (bottom left), 24 (top right), 27 (top right), 28 (top right), 29 (residence), 30 (photos), 31 (bottom right), 36 (bottom), 40 (photo), 42 (top), 45 (photos), 46, 48, 52 (center), 53 (left, top and bottom), 54, 71

Photographs and postcards on the following pages courtesy Florida State Archives, Florida Photographic Collection:  
2 (top right), 3 (right, top and bottom), 23 (right)

Postcard of a Delray Beach streetscape, page 14, and 1920s photograph of a Mission style house in Delray Beach, page 26,  
courtesy Delray Beach Historical Society

Photographs of Old School Square on page 64 courtesy Old School Square Cultural Arts Center

Photograph of Orange Grove House of Refuge, page 2, from Lora Sinks Britt's book *My Gold Coast: South Florida in Earlier Years*

Ca. 1910 photograph of the original bridge over the East Coast Canal (Intracoastal Waterway), page 31, from  
Donald W. Curl's book *Palm Beach County: An Illustrated History*

Illustrations on the following pages adapted from illustrations in *Model Guidelines for Design Review, A guide for developing standards for historic rehabilitation in Florida communities*, Division of Historical Resources, Florida Department of State:

Front cover, 20, 21, 23, 24, 26-30, 34, 39, 49, 50

Illustrations on pages 25, 40 and 41 adapted from *Design Guidelines for Historic Places, A Preservation Manual*, 1990, City of Delray Beach

Shutter illustrations on page 45 adapted from *Resourceful Rehab, A Guide for Historic Buildings in Dade County*, 1987, Metropolitan Dade County

Illustrations of window shuttering systems on page 58 adapted from *Preservation Information*, 1997, National Trust for Historic Preservation

Illustration of double-hung sash window on page 75 courtesy City of West Palm Beach Historic Preservation Office

All other photos and illustrations courtesy of Janus Research

# City of Delray Beach Design Guidelines

## TABLE OF CONTENTS

**Section I. Purpose Of Design Guidelines 1**

Frequently Asked Questions ..... 1

The City of Delray Beach: A Historical Overview..... 2

    The Florida Land Boom and Bust ..... 3

    The Great Depression through World War II ..... 3

    The Aftermath of World War II to the Present ..... 4

**Section II. Identifying And Preserving The City’s Historic Legacy 5**

The Delray Beach Local Register of Historic Places ..... 5

Designation Criteria ..... 5

Historic Districts ..... 5

    Contributing and Non-Contributing Resources ..... 6

    Old School Square Historic District..... 8

    Nassau Park Historic District ..... 9

    Del-Ida Park Historic District ..... 10

    Marina Historic District ..... 11

    West Settler’s Historic District ..... 12

The National Register of Historic Places ..... 13

    Properties Listed in the National Register of Historic Places ..... 13

Historic Sites Surveys ..... 14

**Section III. Review 15**

Local Historic Designation Criteria ..... 15

    Criteria for Significance ..... 15

Certificates of Appropriateness ..... 16

<b>Section IV.</b>	<b>Prevalent Styles of Architecture</b>	<b>19</b>
	Introduction .....	19
	Chronology .....	19
	About Architectural Style .....	19
	Vernacular (Frame and Masonry) .....	20
	Masonry Vernacular: Residential (1890–1940) .....	21
	Masonry Vernacular: Commercial (1890–1940).....	22
	Bungalow (1910–1940) .....	23
	Colonial Revival (1900–1930) .....	24
	Minimal Traditional (1935–1950) .....	25
	Mission (1919–1940).....	26
	Mediterranean Revival/Spanish Eclectic (1920–1940) .....	27
	Monterey (1925–1940) .....	28
	Art Deco (1925–1940) .....	29
	Art Moderne/Streamline Moderne (1930–1945).....	30
	Contemporary (1950–1970) .....	31
	Ranch (1935–1975).....	32
<b>Section V.</b>	<b>Design Principles and Recommended Rehabilitation Treatments</b>	<b>33</b>
	Design Review by the Delray Beach Historic Preservation Board .....	33
	Exterior Surfaces And Materials .....	33
	Wood Siding .....	34
	Masonry (Concrete Block, Brick, Hollow Clay Tile, Stucco) .....	36
	Paint.....	38
	Foundations .....	39
	Roofs .....	40
	Chimneys.....	42
	Windows .....	43
	Decorative Shutters .....	45
	Decorative Awnings .....	46



<b>Section VI:</b>	<b>New Construction</b>	<b>47</b>
	Applicable Secretary Of The Interior’s Standards .....	47
	Additions .....	47
	Infill Buildings .....	48
	Recommended Approaches to New Construction .....	49
<b>Section VII.</b>	<b>Special Design Considerations</b>	<b>51</b>
	Parking.....	51
	Paving Materials .....	51
	Accessory Structures.....	52
	Signage.....	53
	Fire Stairs .....	55
	Handicap Accessibility .....	55
	Fences and Walls .....	56
	Screening of Parking Lots .....	56
	Hurricane Preparedness for Historic Structures.....	56
	Historic Buildings, Assets and Vulnerabilities.....	57
	Window Shuttering Systems .....	57
	Guidelines in the Choice of Shuttering Systems.....	58
	Impact Resistant Glass .....	58
	Mechanical Systems: Heating, Ventilation and Air Conditioning (HVAC), Electrical, Plumbing, Fire Protection .....	59
	Rehabilitation Treatments .....	59
	Florida Building Code: Alternative Materials and Methods for Special Historic Buildings.....	60

<b>SECTION VIII: Historic Preservation Incentives</b>	<b>65</b>
Federal Level: Investment Tax Credit (ITC) .....	65
Local Level: Ad Valorem Tax Incentives .....	65
Community Redevelopment Agency (CRA): Historic Façade Easement .....	66
<b>Appendix A. Certificate of Appropriateness – Approval Matrix</b>	<b>67</b>
<b>Appendix B. The Secretary of the Interior’s Standards for Rehabilitation</b>	<b>69</b>
<b>Appendix C. A Glossary of Frequently Used Terms</b>	<b>71</b>
<b>Appendix D. Additional Resources, State and Federal Agencies, Organizations</b>	<b>77</b>

## SECTION I. PURPOSE OF DESIGN GUIDELINES

### FREQUENTLY ASKED QUESTIONS

#### *Why have design guidelines?*

The city of Delray Beach has a rich and colorful history that takes physical form in its historic architecture. These historic properties define the period of the city's growth, and are expressions of another age. They give character and a sense of permanence to the city that, in turn, helps to stabilize property values, promote interest in local history and foster civic pride.

The historic preservation program in Delray Beach began in 1987 with the enactment of an ordinance by the City Commission. The ordinance establishes formal procedures and standards that are used to judge the merit of historic properties and identifies measures that will protect those properties. One of these protective measures is to review significant changes, such as alterations or additions, to historic properties, in order to preserve their character while responding to the needs of the present.

The Delray Beach Design Guidelines were produced to assist owners with recommended approaches to additions, alterations and design for new construction for both historic districts and individual sites. Because they are *guidelines*, there is always an allowance for interpretation; and because they involve a design process, there may be more than one successful solution. Design guidelines also are used by city staff, the Historic Preservation Board and city officials in their decision making process when considering the issuance of a Certificate of Appropriateness.

The goal of the historic preservation program in Delray Beach is to develop a vibrant and unique historical setting that co-exists with and compliments evolving new development. An important step in achieving this goal is to identify the unique character of the city's architecture so that future changes to important historic properties are consistent with accepted preservation principles.

#### *Who may use these guidelines?*

Design guidelines are intended as a useful tool for design professionals, homeowners, government officials and other interested parties. Because the guidelines address the character of historic property types in general, anyone who rehabilitates an older building can find relevant information in this guide. **While the guidelines are especially directed to owners of properties that are listed in the Delray Beach Register of Historic Places, who are required to undergo a review process when changes to a historic building are made, they are equally useful to anyone who is involved in the rehabilitation of a vintage property.**

#### *How are the design guidelines administered?*

The City of Delray Beach's Historic Preservation Ordinance established a citizen review board composed of both laypersons and professionals who are empowered to judge the appropriateness of an alteration or addition in consultation with the Board liaison. The city's Historic Preservation Planner is a staff member of the Planning and Zoning Department, and should be consulted for any questions, or to receive any additional information.

The Delray Beach Preservation Planner may be reached at the Planning and Zoning Department, City Hall, First Floor, 100 Northwest First Avenue, Delray Beach (561) 243-7040, or e-mail at [pzmail@MyDelrayBeach.com](mailto:pzmail@MyDelrayBeach.com).

## THE CITY OF DELRAY BEACH: A HISTORICAL OVERVIEW



*Orange Grove House of Refuge, built in 1876*

The development of the city of Delray Beach began in 1876 when the Orange Grove House of Refuge No. 3 was constructed by the United States Life Saving Corps on the shores of the Atlantic Ocean in what is now Delray Beach. Several years later, Michigan native William S. Linton platted the town he named for himself, and encouraged others to join him.

The next stage of growth for the new town occurred with the propitious arrival of Henry Morrison Flagler's Florida East Coast Railway (FEC) in 1896. Flagler's Model Land Company, along with Mr. Linton, surveyed the land, platted subdivisions and officially recorded the new settlement as the Town of Linton. African-American families from northern Florida also began to arrive; they established a settlement just west of Linton's land, known as "The Sands" because of its sandy soil, which today encompasses the West Settler's Historic District. Following the initial settling of the area, many of the pioneer black families encouraged their relatives and friends to join them in southeast Florida.

However, the end of the nineteenth century would test the mettle of these new pioneers. After a freeze that destroyed crops and a hurricane that devastated property, many of those early settlers were financially ruined. Even William Linton was affected and most of his land holdings went into foreclosure.

Because the name "Linton" became associated with these unfortunate events, the remaining citizens decided to change the name of the town. They agreed upon "Delray," the name of the Michigan town where some of them were raised.

Around 1900, Flagler's Model Land Company brought in a number of Japanese immigrants who settled just south of Delray. Along with their founder, Jo Sakai, they formed a colony called "Yamato." Flagler encouraged them to establish farming communities, and pineapples became their principle cash crop. Sakai recruited young men from his

village in Miyazu, and from other surrounding towns, to emigrate to Florida. Settlers in the Yamato Colony frequented the town of Delray, often participating in social events, educational activities and trade with both the white and African-American citizens of the town. The settlement never exceeded more than 100 people, and because of a downturn in the pineapple market and competition from pineapple growers in Cuba, by the 1920s the colony had all but vanished. Many of those Japanese pioneers returned to their own country. The Morikami Gardens in Delray Beach founded by George Sukeji Morikami, an early settler in the Yamato Colony, preserves and interprets that Japanese life in Florida.

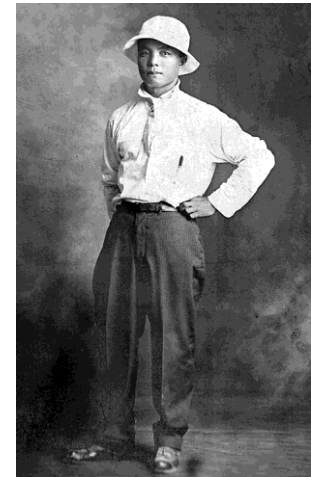

*Photograph of George S. Morikami, taken in 1910*

Bahamians also made their way to Delray Beach, having established a thriving community in both Key West and the Miami area in the late nineteenth century. They settled in a community located in southwest Delray, which earned the name "Frog Alley" because of the constant flooding which brought droves of the amphibians to the water-soaked streets.

As residential development was on the increase, agriculture remained Delray's main industry and pineapple was one of the main crops grown. An article in the *Tropical Sun* from Nov. 6, 1913 proclaimed that Delray had the "largest canning factory south of Baltimore," which primarily canned pineapples. Tomatoes also were considered a major cash crop in the area.

During the first decade of the twentieth century, largely because of regular freight and passenger train service, the town began to experience a transition from an isolated farming community to a vacation destination. By this time the town of Delray had a post office, two schools, a general store and a commissary.

Between 1910 and 1920, the town prospered and on October 9, 1911, the town of Delray was incorporated. John Shaw Sundy was elected the first mayor. That same year, Palm Beach County was established. It formerly had been a part of Dade County, which then extended all the way north to Juno.



*Circa-1910 photograph of the original bridge over the East Coast Canal (Intracoastal Waterway)*

As the central part of Delray was developing in the 1910s, an early subdivision known as Osceola Park was established south of town between the FEC Railway tracks and the Florida East Coast Canal. As one of Delray's first planned neighborhoods, Osceola Park was very successful and lots were quickly sold.

By 1914, thirty houses already were located in the subdivision and many more were proposed for construction.

### The Florida Land Boom and Bust

Following WW I, the United States entered a period of prosperity that was, as yet, unequalled. With the Model T automobile now affordable and a federal highway system built that allowed access to previously isolated areas, America was on the move. The state of Florida was to experience a real estate phenomenon, commonly referred to as "The Boom," that would increase its population and development exponentially. Known as the "Ocean City," Delray, with its prime location on the waterfront and wealth of available land, was to experience a transformation.

Land auctions were held every day in a tent on Atlantic Avenue. In order to accommodate the influx of winter visitors and new residents, commercial and residential buildings sprang up throughout the town. The small-town atmosphere of Delray and its main street of Atlantic Avenue quickly changed into a more exciting and cosmopolitan resort environment. Buildings such as the Arcade Building, built in 1923; the Altrep (now the Colony) Hotel, built in 1926; the Seaboard Air Line Railway Station, built in 1927; the Casa Del Ray Hotel, built in 1925; and the high school and gymnasium (now Old School Square), built in 1926, contributed to the new look of the town.

Numerous new subdivisions also were being developed throughout the town, including Del-Ida Park, Lake Ida Gardens, Crest Lake Park, and Homewood. In January 1922, the Floridixi Farms Company recorded a plat for the Dell Park subdivision. Located north of the city's central

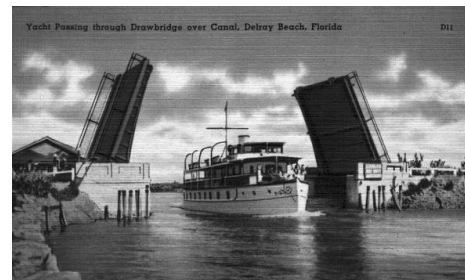

*Postcard of yacht traveling on the East Coast Canal*

core, between Swinton Avenue and the FEC Railway, the 50-foot-wide lots were affordable to middle-income families, who paid between \$5,000 and \$6,000 for a home of their own.

In 1923, the area between the East Coast Canal and the Atlantic Ocean incorporated to form the town of Delray Beach. Construction in this new town was also booming and buildings such as the Seacrest Hotel (1925) were built. In 1927, the towns of Delray and Delray Beach were united and incorporated into the city of Delray Beach.

Though the city was thriving, its success would not last. By the end of 1925, many real estate investors began to cancel all their transactions as they became panicked by news of bogus Florida real estate ventures. The prices and demand for Florida real estate had been so exaggerated that there was little basis for the inflated market. In August 1925, the FEC Railway refused to ship anything but perishable goods, eliminating the transport of all building materials, which were necessary if building were to continue. Further, two devastating hurricanes swept through Palm Beach County in 1926 and 1928, further exacerbating the impending economic depression. The hurricane of September 16, 1928 directly impacted Delray Beach, destroying more than 227 houses. By the time the stock market crashed in October 1929, signaling economic disaster for the nation, Florida's real estate was virtually worthless.



*The Colony Hotel (originally known as the Hotel Altrep) was constructed in 1926 in the Mediterranean Revival style.*

### The Great Depression through World War II

Despite the hardships of the Depression, Delray Beach maintained its status



as a resort community during the 1930s. By 1940, the population of the city had reached a reported 3,661 residents. Subdivisions such as Ocean Breeze Estates and Seabreeze Park were platted and developed at this time.

In 1939, world events leading to U.S. involvement in WW II would greatly change the face of Florida. The state became one of the nation's major training grounds for the Army, Navy, and Air Force. Until that time, tourism had been the state's major industry, but that was brought to an abrupt end as hotels were converted for use as military facilities. The influx of thousands of servicemen and their families increased industrial and agricultural production in Florida, and also introduced them to the warm weather and tropical beauty of Florida.

Within close proximity to wartime facilities, such as Morrison Field in West Palm Beach, Camp Murphy in Hobe Sound, and the nearby Boca Raton Army Air Field, Delray Beach was at the center of southeast Florida's military involvement. Many local men signed up for the armed services while Delray's female population ran their husbands' businesses and participated in war-related volunteer activities. In the evenings, blackouts were required for the oceanfront homes, since German submarines were patrolling off Florida's east coast.

Because Boca Raton Army Air Field was not far from Delray Beach, many military personnel and families resided in the city during the war. Having enjoyed the relaxed atmosphere and pleasant climate, following the conclusion of World War II in 1945, hundreds of servicemen remained in the Delray Beach/Boca Raton area.

### The Aftermath of World War II to the Present

The physical development of most communities in Florida had dramatically slowed during the war years from 1939 to 1945. In the late 1940s, as life began to return to normal, growth throughout the state, including Delray Beach, quickly resumed. When relocated veterans faced a housing shortage, pre-fabricated homes were quickly and efficiently constructed using the latest in building technology. In addition to the year-round population, the tourist population also increased, once again reaching pre-war levels.

In the 1960s and 1970s, another wave of residents flooded Palm Beach County when several corporations, including IBM and Motorola, built their headquarters and manufacturing facilities in the area. Growth exploded in the suburbs and

new shopping centers drew people away from the city's core. Unfortunately, this westward growth negatively affected the older portions of the city; along Atlantic Avenue, commercial buildings became empty and the streets and sidewalks suffered from neglect.

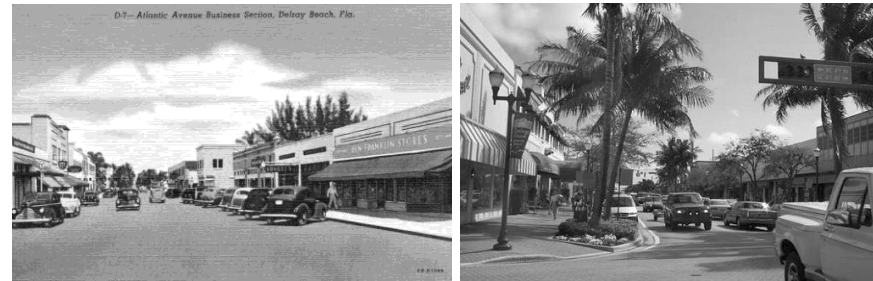

*Historic postcard of Atlantic Avenue business section as it appeared in earlier decades (left), and a more recent photograph of a revitalized Atlantic Avenue*

By the late 1980s, Delray Beach took steps to reclaim its historic resources, and efforts were soon underway to revitalize the historic heart of the city. Various civic, private, and governmental agencies worked together to improve conditions. The city passed a \$21 million bond that facilitated streetscape improvements on Atlantic Avenue and in the surrounding residential areas. Several historic resources, including the Seaboard Air Line Railway Station, were listed in the *National Register of Historic Places* and the historic school buildings that comprise Old School Square were rehabilitated.

In 1987, Delray Beach enacted a preservation ordinance that created the Delray Beach Local Register of Historic Places and established a process to evaluate the significance of historic resources. The ordinance also provides protective provisions for historic properties, which include design review for alterations and additions and a provision for a demolition moratorium.

Today, Delray Beach is a thriving and growing community. Newer immigrants from Latin America and the Caribbean have influenced the city's cultural landscape. The city's small town charm, cultural diversity, and historic buildings, as well as its close proximity to the beach, make it a popular destination for both tourists and residents. Delray Beach is continuously progressive in its development and sensible growth strategies, while remembering the path and the people who established the community that thrives today.



## SECTION II. IDENTIFYING AND PRESERVING THE CITY'S HISTORIC LEGACY

### THE DELRAY BEACH LOCAL REGISTER OF HISTORIC PLACES

The Delray Beach Local Register of Historic Places (“Local Register”) is a listing and a means by which to identify, classify, and recognize buildings, structures, sites, objects and districts that are architecturally/archaeologically significant, as well as archaeological sites that are important to the history of the region.

The Historic Preservation Board, the City Commission or property owners may nominate properties for recognition as historic places. After a preliminary nomination report is prepared that explains the importance of the historic resource or historic district, the Historic Preservation Board reviews that information. If the Board finds that the historic resource is important under the established criteria, the nomination will be reviewed with more detailed information at a later meeting. When the formal report is made at a public hearing, the Historic Preservation Board will vote whether to designate the property or district for local historic designation. If the vote is in favor, the nomination will be forwarded to the City Commission for final approval. After a favorable vote by the City Commission, an ordinance is enacted and the property or historic district is officially listed in the Delray Beach Local Register of Historic Places.

### DESIGNATION CRITERIA

The Historic Preservation Board is charged with determining whether or not a property or district nominated to the Local Register has value or interest in the historical, cultural, and/or architectural heritage of the city of Delray Beach, the state of Florida, and/or the nation. To qualify for listing, the Board must find that the nominated property meets one or more of the following criteria:

- It is associated with the life of a major person important in city, state, or national history;
- It is the site of an historic event with a significant effect upon the city, state, or nation;
- That it exemplifies the historical, political, cultural, or social trend of the community in history;
- It is associated with a past or continuing institution which has contributed substantially to the city's life;
- That it portrays the environment in an era of history characterized by a particular architectural style;
- That it embodies the distinguishing characteristics of an architectural style, period, or method of construction;
- It is a historic or outstanding work of a prominent architect, designer, landscape architect, or builder; or
- That it contains elements of design, detail, material, or craftsmanship of outstanding quality, or which represented, in its time, a significant innovation or adaptation to the South Florida environment.

For properties of *archaeological significance*, they must meet the test as to whether or not they have yielded or may yield information important in history or prehistory.

### HISTORIC DISTRICTS

A historic district is defined as a geographically definable area, possessing a significant concentration, linkage or continuity of sites, buildings, structures or objects united by past events, or by their plan or physical development. A district covers an area with contiguous boundaries, whereas an individual historic resource will stand alone in the argument for its significance.

In virtually every neighborhood, there have been changes over the course of time. There are also different growth periods represented that frequently span decades. When there is a concentration of buildings that are at least 50 years old, and when they have not been seriously altered, a historic district may be identified.

### Individually Listed Local Register Properties

1. **Scott House** – 19 Andrews Avenue
2. **Fontaine Fox House** – 610 N Ocean Boulevard
3. **Site of School No. 4 Delray Colored School** – NW 5<sup>th</sup> Avenue
4. **Greater Mount Olive Missionary Baptist Church** – 40 NW 4<sup>th</sup> Avenue
5. **St. Paul’s African Methodist Episcopal Church** – 119 NW 5<sup>th</sup> Avenue
6. **Free & Accepted Masons of Delray Beach** – 85 NW 5<sup>th</sup> Avenue
7. **St. Matthew’s Episcopal Church** – 404 SW 3<sup>rd</sup> Street
8. **The Koch House** – 777 N Ocean Boulevard
9. **Sundy Feed Store** – Morikami Museum
10. **Historic Depot Square** – 1525 West Atlantic Avenue
11. **The Colony Hotel & North Annex** – 525 East Atlantic Avenue
12. **Milton-Myers Post No. 65 American Legion of the U.S.** – 263 NE 5<sup>th</sup> Avenue
13. **Solomon D. Spady House** – 170 NW 5<sup>th</sup> Avenue
14. **Susan Williams House** – 30 NW 3<sup>rd</sup> Avenue (relocated to 154 NW 5<sup>th</sup> Avenue)
15. **The Blank House** – 85 SE 6<sup>th</sup> Avenue
16. **The Monterey House** – 20 N Swinton Avenue
17. **The Historic Bungalow** – 24 N Swinton Avenue
18. **The Sandoway House** – 142 S Ocean Boulevard
19. **The Trinity Evangelical Lutheran Church Chapel** – 400 N Swinton Avenue
20. **The Turner House** – 145 NE 6<sup>th</sup> Avenue
21. **The Price House** – 1109 Sea Spray Avenue
22. **The Fellowship Hall of the First Presbyterian Church of Delray Beach** – 36 Bronson Street
23. **Atlantic Avenue Bridge** – East Atlantic Avenue at Intracoastal Waterway
24. **George Bush Blvd Bridge** – NE 8<sup>th</sup> Street Bridge
25. **Water House** – 916-918 NE 5<sup>th</sup> Street
26. **S.E. O’Neal House** – 910 NE 2<sup>nd</sup> Avenue
27. **The Amelung House** – 102 NE 12<sup>th</sup> Street
28. **The Dewitt Estate** – 1110 North Swinton Avenue
29. **The Hartman House** – 302 NE 7<sup>th</sup> Avenue
30. **The Sewell C. Biggs House** – 212 Seabreeze Avenue
31. **The Harvel House** – 182 NW 5<sup>th</sup> Avenue
32. **Adams Auto Dealership** – 290 SE 6<sup>th</sup> Avenue
33. **Waters-Wellenbrink Residence** – 1108 Vista Del Mar Drive North
34. **The Marina House** – 170 Marine Way
35. **Two Fisher Lane** – 2 Fisher Lane
36. **Rideley Temple Church of God in Christ** – 102 SW 12<sup>th</sup> Avenue
37. **The Clint Moore House** – 1420 North Swinton Avenue

those that are different in the entire area to be considered as an historic district. The key ingredients in evaluating a historic district for nomination to the Local Register are:

- Historic Integrity
- Historic Context
- Historic Significance
- Cultural Significance
- Architectural Significance
- Archaeological Significance

When identifying the historic context and significance of a historic district, the stages of growth in the neighborhood are labeled as “Periods of Significance.” The character of a house constructed in the early twentieth century is vastly different than the character of one constructed during the 1930s and 1940s. While both houses illustrate an evolution, and are all more than 50 years old, each belongs to a specific time frame in history and each period of significance has its singular importance and special characteristics.

Properties in historic districts must relate to the periods of significance that are documented in the historic district nomination. *Properties that were less than 50 years old when the city’s five historic districts were created do not automatically qualify as historic properties once they do reach that 50-year threshold.* In order for those newly eligible properties to be included, a new justification that details the period of significance and special character of the properties must be written, and the historic district so modified.

### Contributing and Non-Contributing Resources

In a historic district, the individual properties that comprise the district may themselves not be eligible for individual listing, but as part of a group, contribute to creating a sense of character that binds the district together as an ensemble.

In every historic district there will normally be buildings or resources that have been recently constructed or older buildings that have been so dramatically altered that they are not recognizable as products of the time they were built.

Because there are these variables of time and change, the historic district nomination must identify those characteristics that are both common and

**Presently, Delray Beach has listed five areas as local historic districts. They are:**

- Old School Square Historic District
- Marina Historic District
- Del-Ida Park Historic District
- Nassau Park Historic District
- West Settler's Historic District

If these newer or altered buildings are scattered throughout the district, and do not severely detract from the homogenous overall character of the historic district, they may be included. However, they will be identified as non-contributing.

**will be evaluated on a case-by-case basis to determine whether they contribute or do not contribute to the character of the historic district.**

The distinction is made in the evaluation of historic districts and is especially important, as the classification assigned will affect the eligibility of the resource for such incentives as the ad valorem tax credit program.

A **contributing** building, site, structure or object **adds** to the historic architectural qualities, historic associations, or archaeological values for which a district is significant because:

- It is usually more than 50 years old;
- It was present during the period of significance; and
- It possesses historic integrity reflecting its character at that time;
- Or is capable of yielding important information about the period; or
- It independently meets the *National Register* criteria.

A **non-contributing** building, site, structure or object **does not add** to the historic architectural qualities, historic associations, or archaeological values for which a district is significant because:

- It usually is not more than 50 years old;
- It was not present during the period of significance;
- It no longer possesses its historic character which would reflect its original character; and
- It is not capable of yielding important information about the period.

**Both contributing and non-contributing buildings are reviewed by the Historic Preservation Board and are considered on their own merits. Relocated buildings that have been moved into a historic district**



*This residence is a non-contributing building to the Del-Ida Park Historic District because its age is not relevant to the period of significance, it has undergone severe window alterations and the carport has been enclosed.*



*This residential structure is a contributing building in the Del-Ida Park Historic District in Delray Beach. The integrity of its original historic elements has been maintained.*

## Old School Square Historic District

Listed in the Delray Beach Local Register of Historic Places, 1988

The Old School Square Historic District was listed in the Local Register in 1988. The inventory of historic architecture ranges from Frame and Masonry Vernacular and Bungalow to Mission and Mediterranean Revival styles dating between 1902 and 1945. The district boundaries expand south to SE 2<sup>nd</sup> Street and north to NE 4<sup>th</sup> Street with NW and NE 1<sup>st</sup> Avenues making up the west and east boundaries. The name of the historic district refers to its focal point, the Old School Square Complex at 51 North Swinton Avenue. Situated in the heart of the downtown, the complex is made up of the city's first high school and original gymnasium. The Crest Theater, facing Swinton Avenue, was built in 1926 in a Mediterranean Revival style. The Cornell Museum (now the Cornell Museum of Art & History), facing Atlantic Avenue, was built in 1913 in a Vernacular style. The arcade that connects the school and museum, and the pavilion complex, were added in 2002.

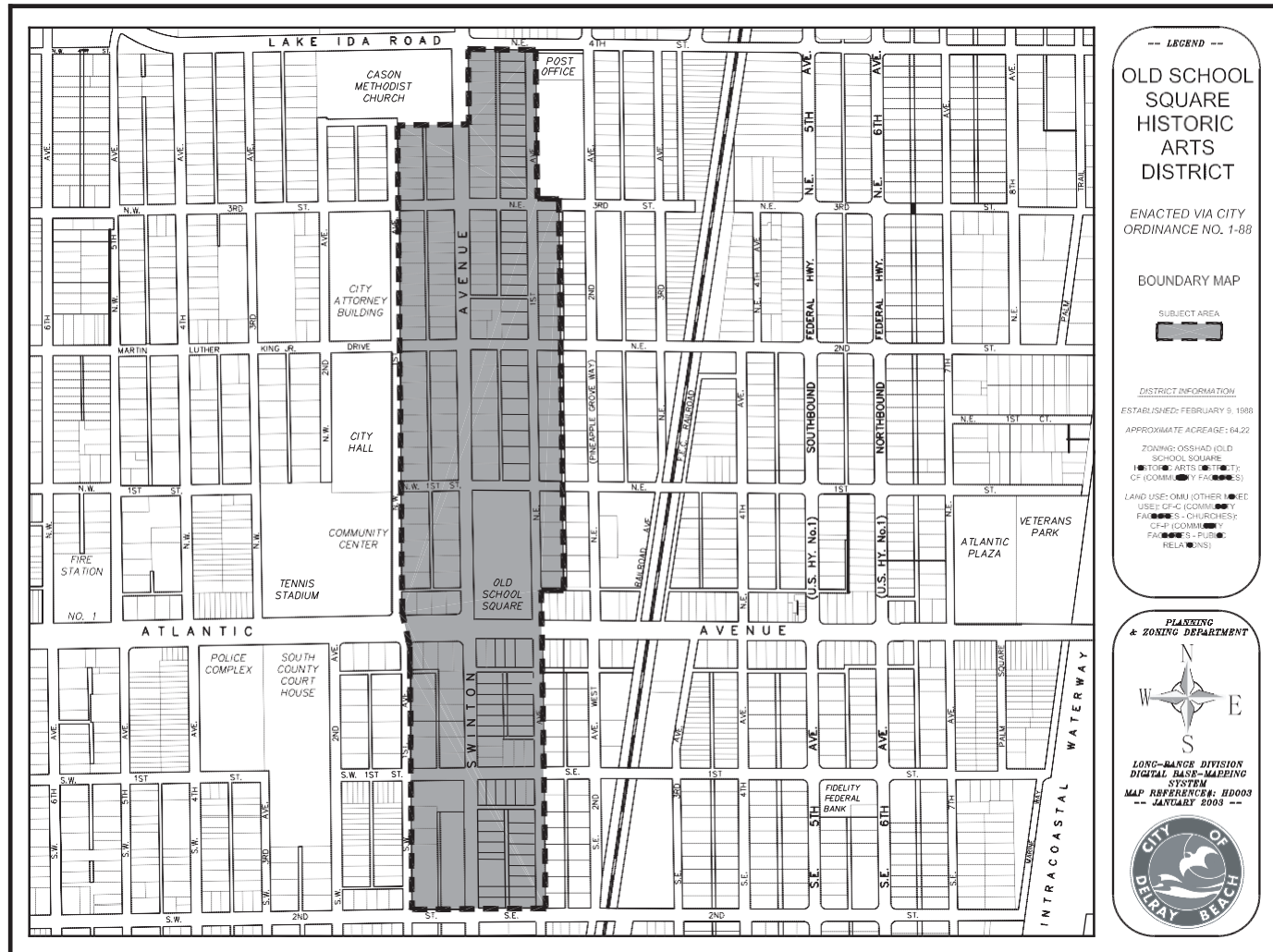

Boundaries for the Old School Square Historic



## Nassau Park Historic District

Listed in the Delray Beach  
Local Register of Historic  
Places, 1988

Nassau Park was the city's first planned residential development south of Atlantic Avenue, and was the first to be designated as a local historic district. The development was intended to compliment the surrounding resorts and hotels along South Ocean Boulevard and the topography of the area. Built in the Minimal Traditional style, dating between 1935 and 1941, the neighborhood remains residential today. Originally named Jo-Jo Avenue, it was renamed by developer R. C. MacNeil, who commissioned architect Samuel Ogren, Sr. to design the first house in 1935. District boundaries include the two-block area of Nassau Street between Venetian Drive to the west and South Ocean Boulevard to the east. Nassau Park was listed as a local historic district in 1988.

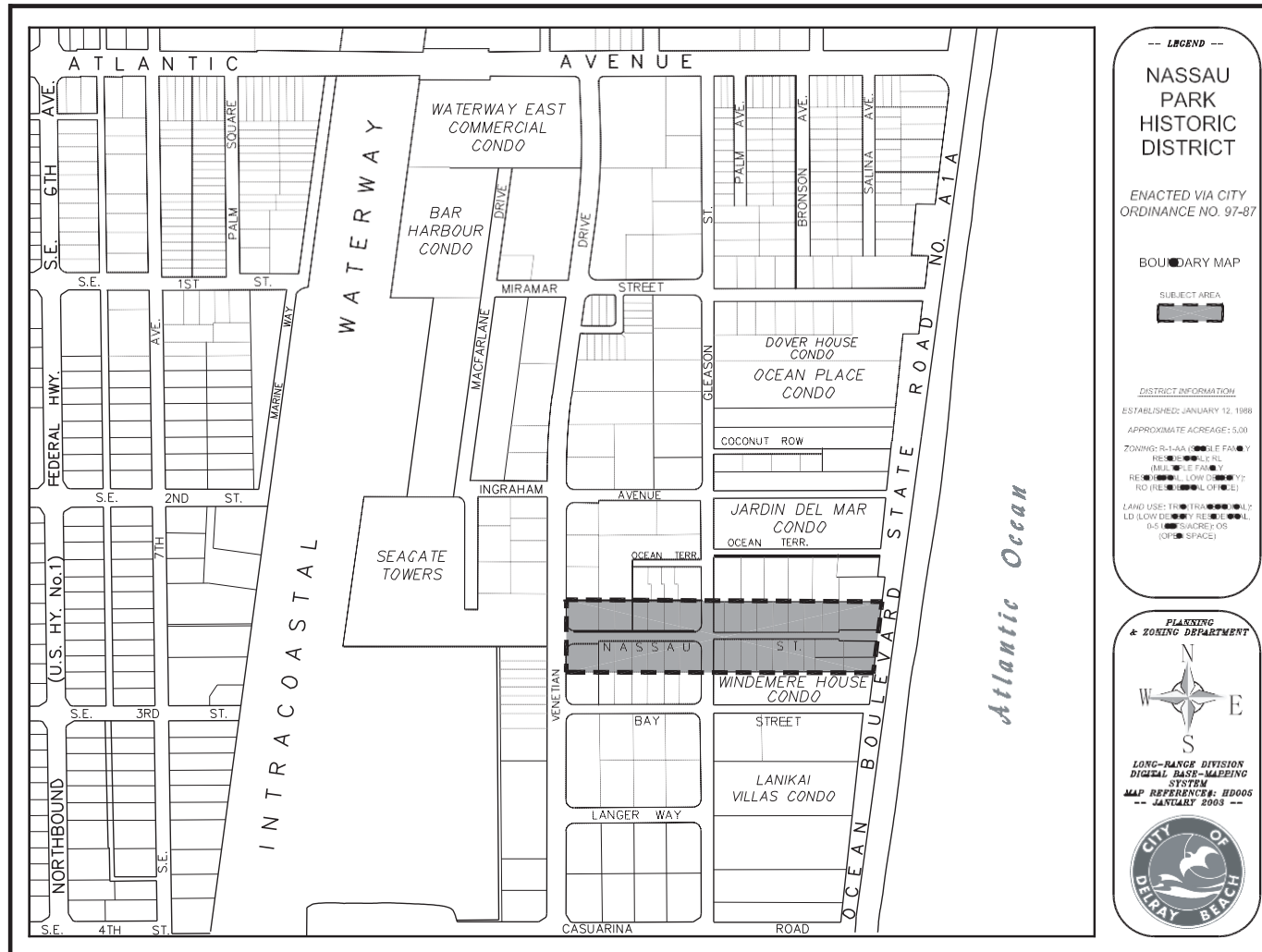

Boundaries for the Nassau Park Historic District

## Del-Ida Park Historic District

Listed in the Delray Beach Local Register of Historic Places, 1988

Recorded in 1923, Del-Ida Park was one of Delray's earliest planned communities. With its unusual diagonal arrangement of streets and triangular lots, Del-Ida Park is unique when contrasted with the grid pattern layout of the remainder of the city. Architectural styles throughout the neighborhood reflect the popular culture of South Florida and the land boom and bust that followed. Dating between the 1920s and 1940s, Mediterranean and Mission Revival styles are prevalent with detailed Bungalows, Craftsman Cottages, and Frame Vernacular dwellings also present. The neighborhood lies between NE 4<sup>th</sup> Street and NE 8<sup>th</sup> Street (George Bush Boulevard), with Swinton Avenue to the west and NE 3<sup>rd</sup> Avenue to the east. Del-Ida Park became a locally-designated historic district in 1988.

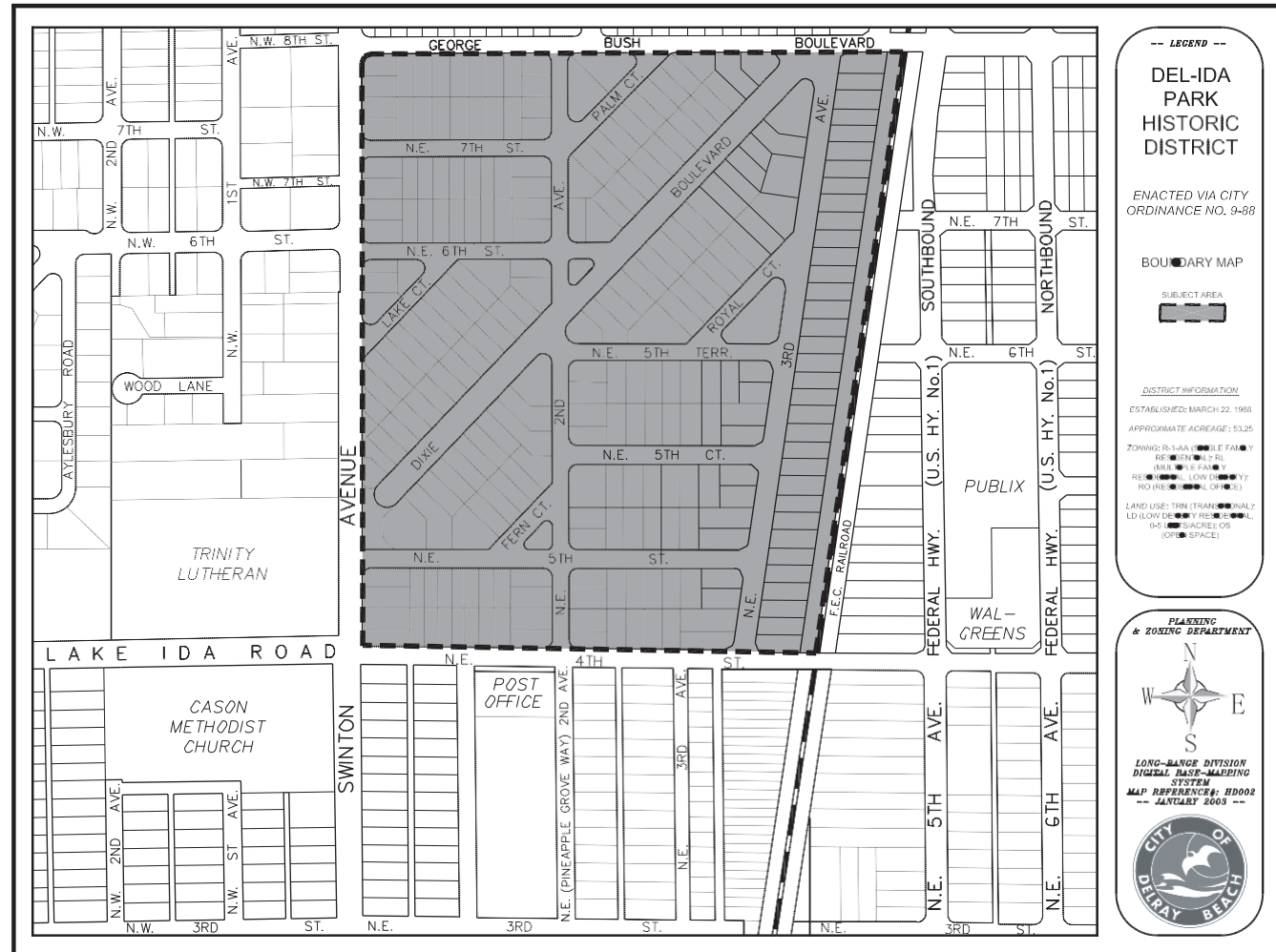

Boundaries for the Del-Ida Park Historic District



### Marina Historic District

Listed in the Delray Beach Local Register of Historic Places, 1988

Constructed predominantly between 1922 and 1943, the district displays various architectural styles ranging from Mediterranean and Mission Revival to Monterey, Frame Vernacular, and Art Moderne. The historic district includes commercial, single-family residences, and multi-family residences. The Boyd Building on East Atlantic Avenue, immediately west of the bridge, is a particularly distinctive example of a large-scale commercial building designed in the Streamline Moderne style. The area was home to many prominent seasonal residents who enjoyed its close proximity to the ocean and the Intracoastal Waterway. The buildings highlight the designs of prominent architects of the day, including Gustav Maas, Samuel Ogren, Sr., and John Volk. The Marina District is bounded by East Atlantic Avenue to the north, SE 4<sup>th</sup> Street to the south, SE 7<sup>th</sup> Avenue to the west and the Intracoastal Waterway to the east. The Marina District was designated a historic district in the Local Register of Historic Places in 1988.

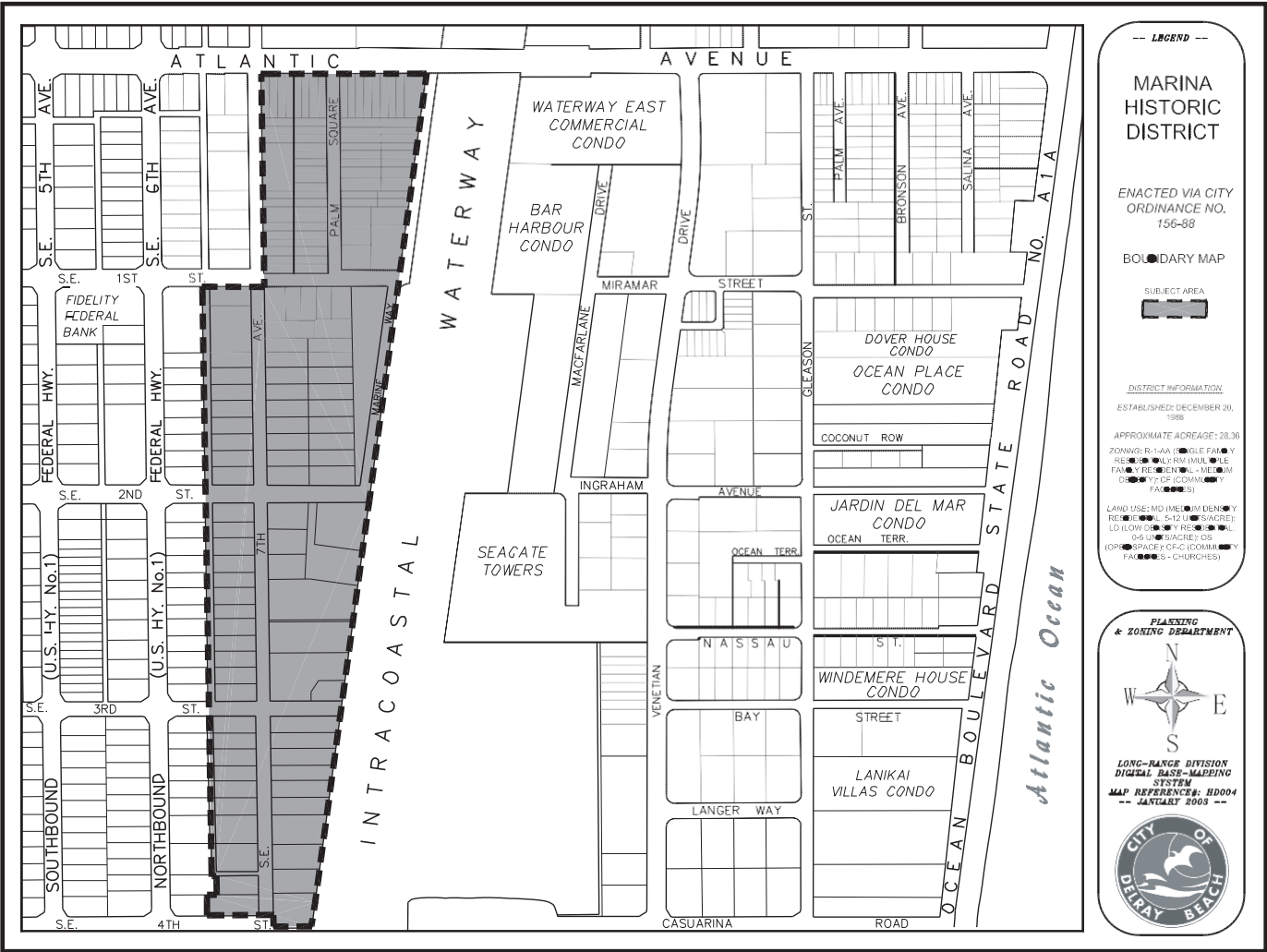

Boundaries for the Marina Park Historic District

## West Settler's Historic District

Listed in the Delray Beach Local Register of Historic Places, 1995

Originally called "the Sands," so named for its sandy soil, the West Settler's Historic District is the site of the first African-American settlement in Delray Beach established in 1894. African-Americans from northern and western Florida, Georgia and South Carolina were the first non-native settlers in the Delray area, pioneering a rich agricultural heritage. The community was self-sufficient, with commercial buildings and churches serving the residents. Dating back to 1905, many Frame Vernacular styles abound in the area, as early settlers utilized both local materials and their own knowledge of construction to develop the built environment. High styles include Bungalow and Mission Revival architecture popularized in the 1920s. West Settler's was designated a historic district in the Local Register in 1995.

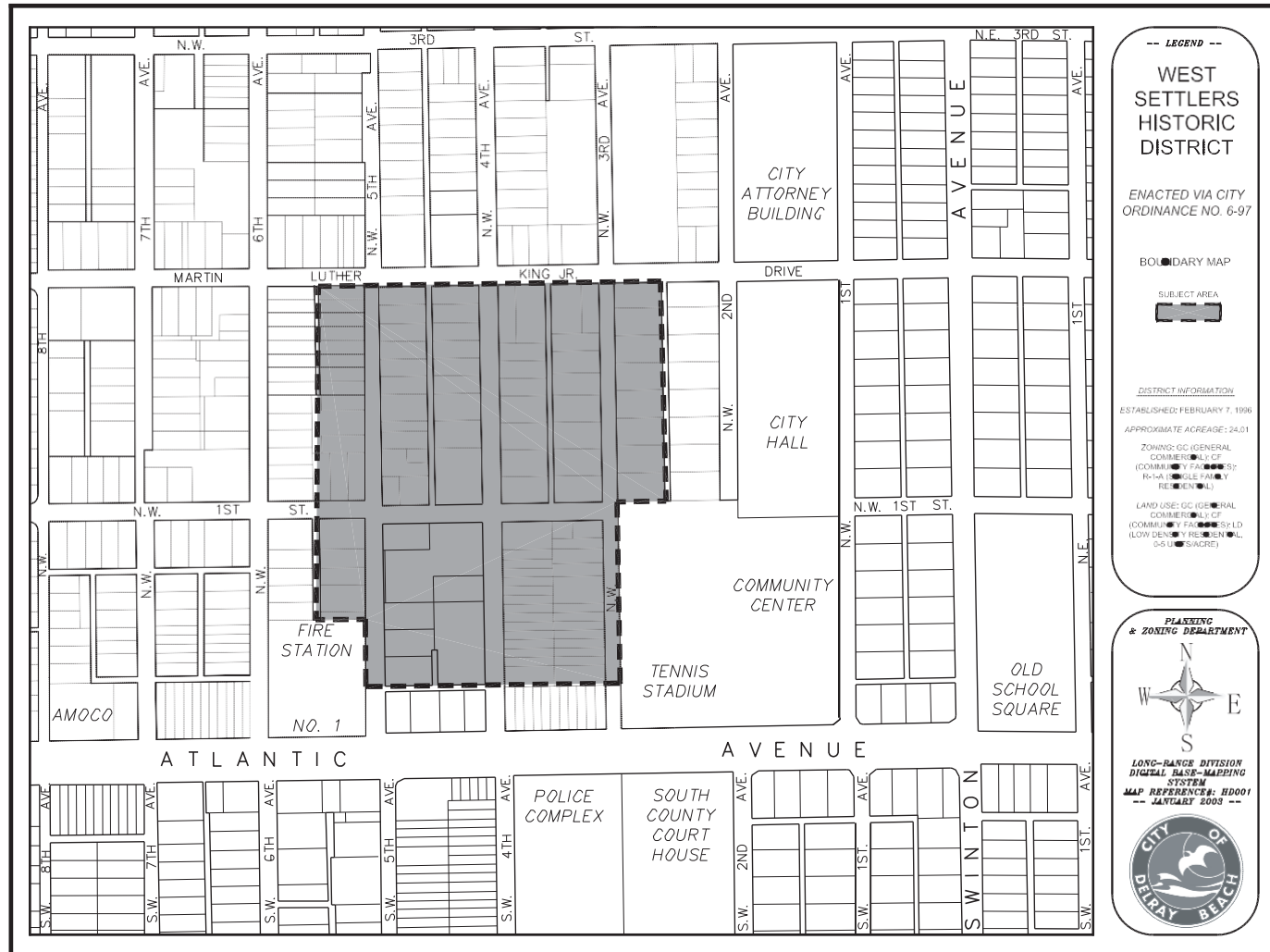

Boundaries for the West Settler's Historic District

## THE NATIONAL REGISTER OF HISTORIC PLACES

With the passage of the *National Historic Preservation Act of 1966*, the National Park Service of the Department of the Interior was charged with maintaining a “National Register of sites, buildings, structures and objects significant in American history, architecture, engineering and culture.” In order to qualify for listing in the *National Register*, a property must **generally be at least 50 years old**, unless it possesses exceptional significance.

***The age of the property alone does not qualify the property for listing.*** The property also must possess integrity of location, design, setting, materials, feeling and association, and meet one or more of the following criteria:

- a. Be associated with events that have made a significant contribution to the broad patterns of our history; or
- b. Be associated with the lives of persons significant in our past; or
- c. Embody the distinctive characteristics of a type, period or method of construction, or represent a significant and distinguishable entity whose components may lack individual distinction; or
- d. Yield, or be likely to yield, information important in prehistory or history.

Forms for the nomination of properties to the *National Register of Historic Places* may be requested from the Survey and Registration Section, Division of Historical Resources, R.A. Gray Building, 500 South Bronough Street, Tallahassee, Florida 32399, or for further information visit the DHR Web site at <http://dhr.dos.state.fl.us>.

Anyone with the necessary expertise may nominate a property to the *National Register*. However, if an individual site is nominated and the owner objects, the property will not be listed, (although it may be determined eligible for listing). In the case of a historic district, 51% or more of the owners must object to prevent the listing.

The process for nomination and listing in the *National Register* first requires its review by the Delray Beach Historic Preservation Board. The nomination should first be submitted to the city’s Historic Preservation Planner. At a public hearing, the Board will evaluate the nomination based on the criteria for significance and make its recommendation to the Florida National Register Review Board. That Board will review the nomination at one of its quarterly meetings, and should it find that the property meets one or more of the criteria, will forward the nomination to the Keeper of the *National Register* in Washington, D.C. for final approval and listing.

### Delray Beach Properties Listed in the National Register of Historic Places

The J.B. Evans House(Sandoway House)  
142 South Ocean Boulevard  
*Listed: March 28, 2002*

The Milton-Myers American Legion Post No.65  
*Listed: April 20, 1995*

The Seaboard Airline Railroad Station  
*Listed: September 4, 1986*

The John Sundry and Elizabeth Shaw House  
*Listed: January 16, 1992*

Old School Square Complex  
*Listed: 1988*

Marina Historic District  
*Listed: 2014*

Old School Square Historic District  
*Listed: 2018*

## HISTORIC SITES SURVEYS

### Historic Surveys Conducted in the City of Delray Beach

The 1987 Delray Beach Historic Sites Survey inventoried properties in the locally-designated Marina Historic District, Nassau Park Historic District, Old School Square Local Historic District, Del-Ida Park Local Historic District, West Settler's Historic District, and the Vista Del Mar area. As a result of this survey, 285 properties built before 1940 were identified.

The Delray Beach Historic Resources Survey (Phase I) was completed in 1999, and included the Dell Park and Osceola Park neighborhoods, the commercial district along Atlantic Avenue, and resources located on the barrier island between the Intracoastal Waterway and Atlantic Avenue. The survey report, available in the office of Delray Beach's Historic Preservation Planner, includes a summary of the city's architectural and historical development, a timeline chronology, and recommendations for future survey activities.

The Delray Beach Historic Sites Survey (Phase II) was completed in 2002, and identified 500 buildings constructed prior to 1955. The individual site file forms that include a photograph, as well as the findings and recommendations, are available in the office of the Historic Preservation Planner.

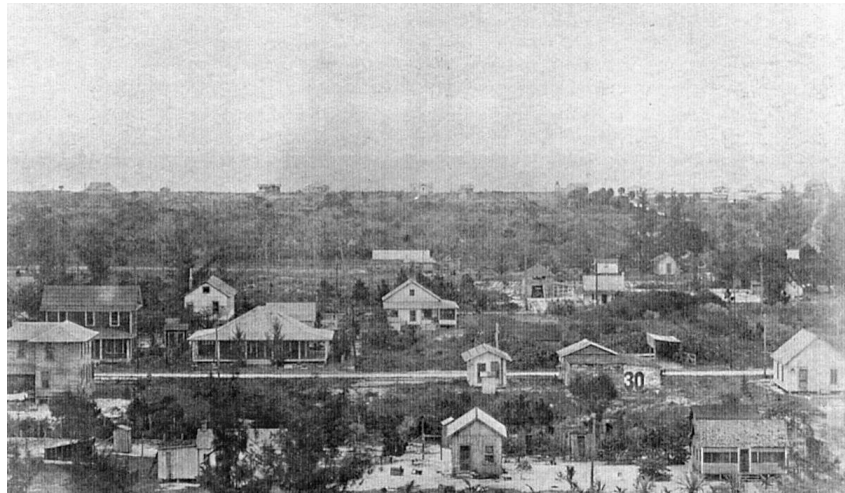

*Postcard featuring a streetscape in Delray Beach*

## SECTION III. REVIEW

### LOCAL HISTORIC DESIGNATION CRITERIA

Special criteria have been established to assist the Historic Preservation Board in the evaluation of applications for local historic designation. To qualify as a historic site or district, the property must meet at least one of these criteria and typically meets more than one. Generally, in order for a property to even be considered for historic designation, it must be at least 50 years old.

#### Criteria for Significance

- Is associated with the life of a person important in city, state, or national history;
- Is the site of a significant historic event associated with the city, state, or nation;
- Exemplifies the historical, political, cultural, or social trend of the community in history;
- Is associated with a past or continuing institution (e.g., health care facilities, schools, organized sports) which has contributed substantially to the city's life;
- Portrays the environment in an era of history characterized by a particular architectural style;
- Embodies the distinguishing characteristics of an architectural style, period, or method of construction;
- Is a historic or outstanding work of a prominent architect, designer, landscape architect, or builder;
- Contains elements of design, detail, material, or craftsmanship of outstanding quality, or which represented, in its time, a significant innovation or adaptation to the South Florida environment; or
- Has yielded, or may be able to yield, information about history or prehistory.



## CERTIFICATES OF APPROPRIATENESS

### *What is a certificate of appropriateness and who needs one?*

Once a property or historic district has been listed in the Delray Beacocal Register of Historic Places, the Historic Preservation Board must review any building activity or demolition requests concerning those historic properties. The vehicle used to do this is called a Certificate of Appropriateness. The Board's objective is to insure that the character and environment of the historic building or district is preserved by preventing incompatible alterations, overwhelming additions, demolitions, and in the case of historic districts, incompatible new construction.

A Certificate of Appropriateness application is filed when alterations, construction, or other work to the **exterior** of a individually listed historic site or building within a designated historic district is proposed. The application process begins with the completion of a form that requests a thorough description of the work that is proposed and that includes sufficient illustrative information that the Board may make a reasoned decision. Following a public hearing (for more complicated projects), a Certificate of Appropriateness may be is issued by the Historic Preservation Board.

Whether the property is residential or commercial, anyone who owns or proposes to alter the exterior of an individually designated historic property or building within a historic district is responsible for filing a certificate of appropriateness application. In the case of a development project that involves historic buildings, the Certificate of Appropriateness process is incorporated into the Site Plan Approval process.

### *If I file an application for a Certificate of Appropriateness, do I also need a Building Permit?*

**The Historic Preservation Board does not supercede or replace the authority and regulations of the Building Department. A building permit is necessary for any construction in the city of Delray Beach.** The concerns of the Historic Preservation Board focus on the design qualities of the project, and how that design respects the historic character of the subject property. The Building Department is responsible for the structural integrity, life safety, accessibility and other building and

regulatory codes that must be in compliance before a permit may be issued. The Certificate of Appropriateness process should be concluded *before* an application for a building permit is submitted.

**No building permits for exterior alterations to historic structures or buildings within a historic district may be issued without administrative approval or approval from the Historic Preservation Board.**

### *What changes can be made to a historic building?*

The goal of historic preservation is to see that historic resources continue to convey their historic character, while at the same time being sensitive to the reasonable needs and concerns of the present. Rehabilitation is a process that respects the character of each historic building while it allows for respectful change. Rehabilitation assumes that alterations will take place in order to make a building useful and practical, and to comply with code requirements that involve life safety, energy conservation and accessibility.

### *Do I need a Certificate of Appropriateness for ordinary maintenance or repairs?*

*Generally*, if a building permit is not required for the proposed work, then a Certificate of Appropriateness will not be needed. Repairs are defined as correcting the deterioration by restoring the damage, as nearly as possible, to the appearance before the deterioration.

A Certificate of Appropriateness is not needed for work on the interior *unless* it was specifically designated.

**When in doubt, check with the city's Historic Preservation Planner.**

### *How can I receive a Certificate of Appropriateness?*

An application for a Certificate of Appropriateness may be requested from the Planning and Zoning Department. The application must be completed, returned to Planning and Zoning, and a filing fee paid. The additional



information that accompanies the application is determined by the project's complexity. For example, the replacement of a roof will require far less documentation than for the construction of an addition.

Typically, for more involved projects, the applicant must submit:

- Site Plans
- Architectural Drawings (Building elevations and floor plans)
- Photographs
- Sketches/Renderings
- Current Survey
- Landscape Plan
- Material Samples
- Color Samples

In a development project that includes historic properties, the COA is an additional requirement that becomes part of any:

- Site Plan Approval
- Conditional Use Approval
- Zoning Changes

In addition to the general requirements, for **new construction** within a historic district, the information should include:

- Enough graphics or photographs to adequately illustrate the streetscape where the property is to be located;
- Illustrations that include (at a minimum) the buildings on either side of the buildable lot; and
- Illustrations that include buildings across the street.

**A pre-application conference with the Historic Preservation Planner is strongly recommended.**

***How is a design evaluated by the Historic Preservation Board; do they have special standards?***

The objective of design review for historic structures is to insure that the original character of the building is maintained. Character is defined as the physical appearance of the building, but in a historic district, will also include its setting. At a minimum, character-defining features include:

- Massing
- Scale
- Building Footprint
- Architectural Details
- Orientation



*The photos above are examples of various architectural styles exhibited in Delray Beach residences. They are (clockwise from top left) Art Moderne, Mediterranean Revival, Ranch, and Minimal Traditional.*

## SECTION IV. PREVALENT STYLES OF ARCHITECTURE

### INTRODUCTION

Cities and towns across America are characterized by the types and design of the buildings constructed for each place. Climate and environment, traditions, available building materials, newly developed technology and current fashion heavily influence the choice and types for regional designs.

In Delray Beach, building forms were largely a result of environmental concerns. For example, to protect residents from storms and animals, foundations were raised off the ground. Because of the durability and ready availability of Dade County Pine, many homes were built with wood frame construction. Roof overhangs and porches provided relief from the rain and sun, and gable ends allowed the space for ventilation.

The city of Delray Beach has a number of recognizable architectural styles that define its character and create its identity. As time progresses, so do the designs for both residential and commercial buildings. One of the ways that progress may be defined is through the identification of the most popular building types during the period.

### Chronology

There are four distinct periods of development in the city of Delray Beach. They may be characterized as The Pioneer Era (1876–1915); The Boom (1923–1926); The Golden Age (1933–1941); and the Post War Era (1942–1954). For each of those chronological divisions, the predominant architectural styles changed and reflected the prevalent social and economic conditions of the day.

### ABOUT ARCHITECTURAL STYLE

There are two principal components that must be considered together when defining an architectural style. The first is the form the building takes, beginning with its plan shape (the outline of its footprint) and structural character. Form is comprised of the interrelationship between proportion, scale, height, depth and width.

Decoration or ornamentation is the second component that gives definition to any particular architectural style, and is usually non-structural in nature. Materials that have been crafted, tooled or formed beyond the need for structure or enclosure are considered to be ornamentation. Typical examples are bargeboards, attic vents, railings, cast concrete shields and medallions, chimney caps and metal grilles.

Delray Beach has a wealth of architectural styles that span decades. The most common types are described in the following pages.

## Vernacular (Frame and Masonry)

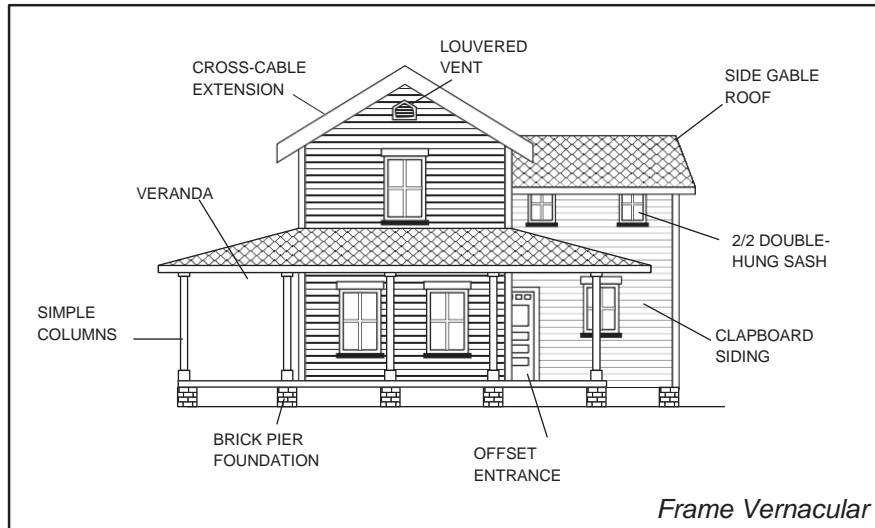

The dictionary describes “vernacular” as something native to a particular area or resident culture. In architecture, the term vernacular is used to embrace a diversity of folk and mass-produced building forms that were transmitted by memory or sometimes by pattern book.

Vernacular buildings typically were designed and constructed by lay builders who utilized traditional building techniques. When America changed from an agrarian nation to a nation with an industrial economy during the late nineteenth century, mass production was made possible, leading to the standardization of building elements. Decorative features



*Frame Vernacular residence*

often were derived from historical styles that may result in a classification of Vernacular with elements that are tied to a specific architectural style. For example, residential buildings in Delray Beach are frequently a vernacular type, but have recognizable features associated with the Mediterranean Revival or Mission styles.

The Vernacular is no less important than examples of recognized traditional architectural styles. In fact, of all the building styles, Vernacular is of the most significant consequence in defining the unique characteristics of a place. In Delray Beach, most of the Vernacular examples are built between the early 1920s and the late 1940s.



*WWI-era Frame Vernacular residence*

### **General Characteristics: Residential Frame Vernacular**

- Plan shape: symmetrical, frequently “L”
- Building material: frame; locally-available materials
- Exterior surface treatment: wood siding
- Roof type: gable or hip
- Height: one or two stories
- Window type: sash
- Foundation: elevated, raised pier
- Other:
  - Shed roof porch across front elevation
  - Ornamentation: rafter tails, cornerboards, vents in the gable ends, and shutters
  - Often a freestanding garage that may reflect details that exist on the main residence



### Masonry Vernacular: Residential (1890–1940)

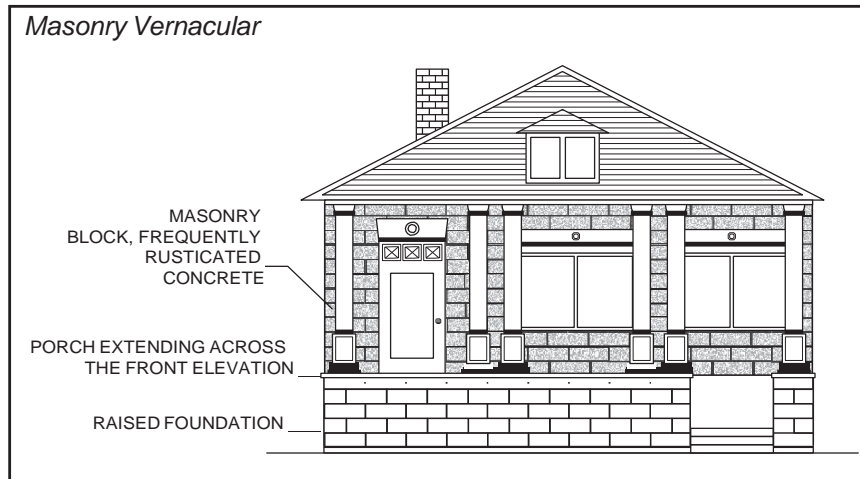

Masonry Vernacular buildings share many of the same characteristics as those constructed in the Frame Vernacular style. They tend to be simple, largely unornamented and constructed from readily available building materials.

While Masonry Vernacular implies a building tradition rather than a formal architectural style, Vernacular structures often employ elements of a more formal style. For example, some of the Vernacular buildings employ a hipped roof and are sheathed in stucco, reflecting a Mediterranean tradition popular during Florida's 1920s Real Estate Boom.

### General Characteristics: Residential Masonry Vernacular

- Plan shape: symmetrical
- Building material: concrete block; hollow clay tile; brick
- Exterior surface treatment: stucco (smooth or textured)
- Roof type: gabled; hipped; cross-gabled; flat
- Height: one or two stories
- Window type: sash; casement
- Foundation: elevated, raised pier
- Other:
  - Roofing materials: barrel tile, flat concrete tile, shingles
  - Ornament: cast concrete; scored stucco, concrete lintels and sills
  - Often, a freestanding garage that may reflect details of the main residence
  - Rusticated exterior surfaces



*Masonry Vernacular residence*

### **Masonry Vernacular: Commercial (1890–1940)**

Almost all of the Masonry Vernacular commercial buildings are located on Atlantic Avenue, one of the city's main commercial corridors. While some of the commercial buildings date from the 1920s, the majority were built in the 1940s.

#### ***General Characteristics: Commercial Masonry Vernacular***

- Plan shape: symmetrical
- Building material: concrete block, hollow clay tile
- Exterior surface treatment: stucco (smooth or textured)
- Roof type: flat
- Height: one or two stories
- Window type: metal frame, fixed glass display windows on first floor
- Other:
  - Decorative coping on parapet



*Masonry Vernacular commercial building*



*Masonry Vernacular commercial building*



## Bungalow (1910–1940)

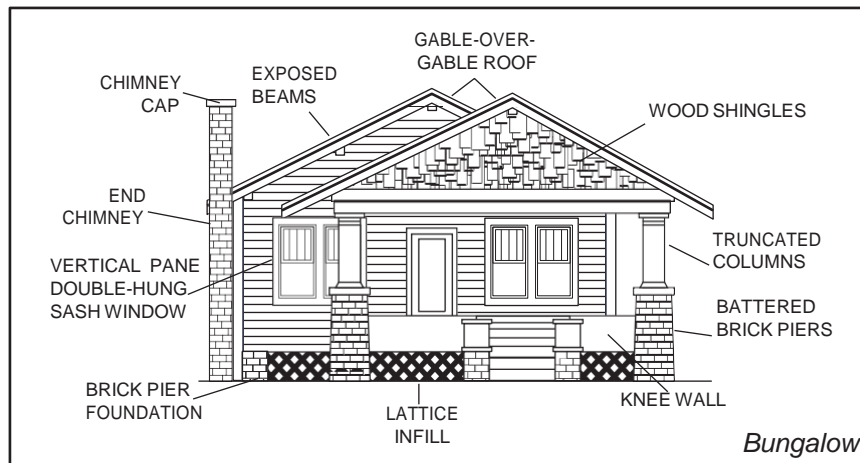

The word “bungalow” originated in India, and comes from the Bengalese *bangla*, meaning “belonging to Bengal.” The British used the term during the beginning of the nineteenth century to describe a low house surrounded by a veranda. Such houses were built by the Indian Government along main roads to serve as temporary rest stops for travelers. These simple, one-story houses that featured porches or verandas across the front, borrowed elements from buildings in the Far East, including India and Japan.



*Bungalow style residence in the Old School Square Historic District*

Bungalows in America were commonplace in the late nineteenth century, particularly in California where they were frequently embellished with elements of the Queen Anne, Stick, Craftsman and Shingle styles. The style was featured at the California Mid-Winter Exposition of

1894 in an exhibition of Japanese construction techniques.

In his 1909 book, *Craftsman Houses*, California architect Gustav Stickley explained that the bungalow is a house reduced to its simplest form. “It never fails to harmonize with its surroundings,” Stickley went on to say, “because its low broad proportions and absolute lack of ornamentation give it a character so natural and unaffected that it seems to sing into and harmonize with its surroundings.”

The enrichment of a Bungalow is through the use of materials, and not the intentional attachment of ornament. The simplicity of the approach



*The George S. Morikami house in Delray Beach*

precluded the use of any non-functional elements, as structural elements were used to express the style. Bungalows were especially popular in Florida from the beginning of the twentieth century into the 1930s.

### General Characteristics:

- Plan shape: symmetrical, usually oriented with the narrow side facing the street
- Building material: masonry or frame
- Exterior surface treatment: frequent use of natural materials
- Height: one to one-and-a-half stories
- Roof type: low gable roof lines with a broad pitch
- Window type: casement; sash, multiple lights
- Other:
  - Masonry piers, often tapered, supporting the porch roof
  - Wide overhanging eaves, exposed rafter tails
  - Brackets (or triangular knee braces) used at the roof line
  - Prominent porches across the main elevation

## Colonial Revival (1900–1930)

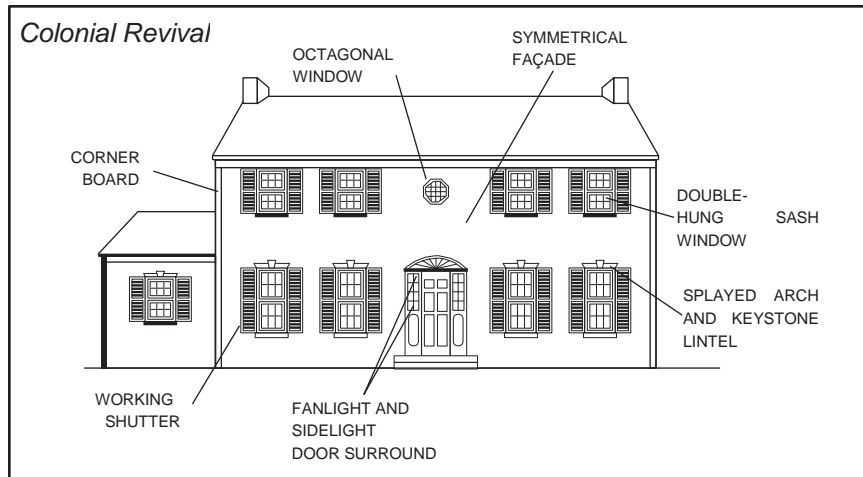

The early origin of this style can be derived from the Philadelphia Centennial Exposition of 1876, where many Colonial-inspired buildings were interpreted. Twentieth century Colonial Revival buildings are usually free interpretations of the original precedents; therefore, elements of Georgian, Federal, or Adam styles often are combined. Early examples of this style were designed by academically-trained architects such as McKim, Mead, White and Bigelow. Their designs tended to exaggerate Colonial detailing rather than attempt to be historically correct. Colonial Revival houses from about 1915 to 1935 strove to be more true to colonial prototypes, while later examples were simpler in design. In Florida, the style exerted a great influence on Vernacular designs. Colonial Revival details are most frequently applied to residential design.

### General Characteristics:

- Plan shape: symmetrical
- Building material: frame
- Exterior surface treatment: wood siding
- Roof type: hip; gambrel on Dutch Colonial Revival
- Height: two to two-and-one-half stories
- Window type: sash
- Other
  - Classically-inspired details such as columns, modillions and dentils
  - Prominent entrance featuring door with sidelights and transom above



*Entrance of a Colonial Revival residence*



*Colonial Revival residence*

### Minimal Traditional (1935–1950)

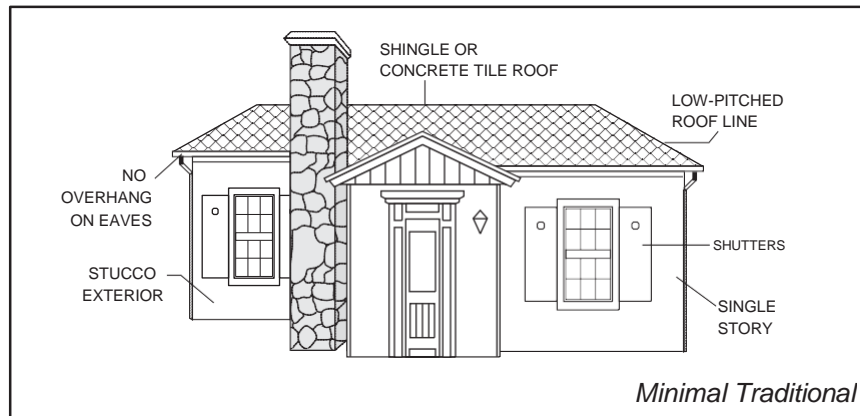

The term Minimal Traditional was coined to describe the transition that occurs in residential design from the period just before World War II through the 1950s. As housing became affordable and new building technologies allowed for prefabrication and mass production, homes became simpler. The GI Bill enacted for returning servicemen enabled the middle classes to become homeowners, many for the first time.

One of these residential types, the Minimal Traditional, relied on the inspiration of the Tudor cottages that were so popular during the 1920s and 1930s. The Tudor inspiration is reflected in the dominant front gable of the main elevation, which frequently features a prominent chimney. The roof pitch has been lowered and ornament is omitted.

#### **General Characteristics:**

- Plan shape: symmetrical
- Building material: frame; masonry
- Exterior surface treatment: clapboard; stucco; sometimes with a partial facing of stone/rock/brick
- Roof type: low-pitched gable
- Height: one story
- Window type: wood frame sash; metal fixed; awning

- Other
  - Front-facing gable
  - Garage bay attached to the residence
  - Eaves are close, no overhangs
  - Roof material: shingles; concrete tile
  - Details: Vents in gable end; shutters; cornerboards.



*Minimal Traditional residence*



*Minimal Traditional residence*



## Mission (1919–1940)

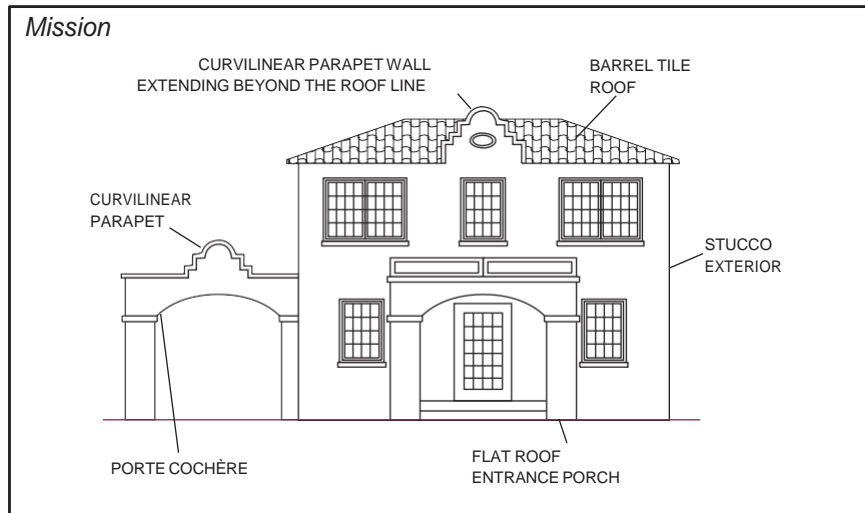

The Mission style can be traced back to the California mission churches established by Father Junipero Serra during the 1700s. These missions were built one day's walk apart and were a symbol of Spain's claim to the New World.



1920s photograph of Mission style house in Delray Beach

Originating in California during the 1890s, houses and buildings in this style were constructed throughout the western states.

When fashionable architects and magazines began promoting the Mission style, it moved eastward. Like California, Florida looked to its Spanish heritage for architectural inspiration. During the first two decades of the twentieth century, the influences of the Craftsman style, or Bungalow,

building type also were evident in the smaller residential Mission prototypes. Within South Florida, the Mission style was among the most dominant style during the Florida Land Boom years.



Mission style residence

The Mission style is sometimes confused with Mediterranean Revival. While the two are extremely similar, and the term Mediterranean Revival refers to an eclecticism and not a pure style, generally the Mission style is distinct because it lacks surface ornament and is therefore much more restrained.

### General Characteristics:

- Plan shape: asymmetrical
- Building material: usually masonry/concrete block, hollow clay tile
- Exterior surface treatment: stucco (rough or smooth textured)
- Roof type: flat; usually not visible behind the parapet which may be shaped
- Height: one to two stories
- Window type: casement; sash
- Residential types frequently include a porte cochère
- Foundation: continuous concrete; slab concrete
- Other:
  - Tile coping along the parapet
  - Tile visor roofs



Mission style commercial building

## Mediterranean Revival/Spanish Eclectic (1920–1940)

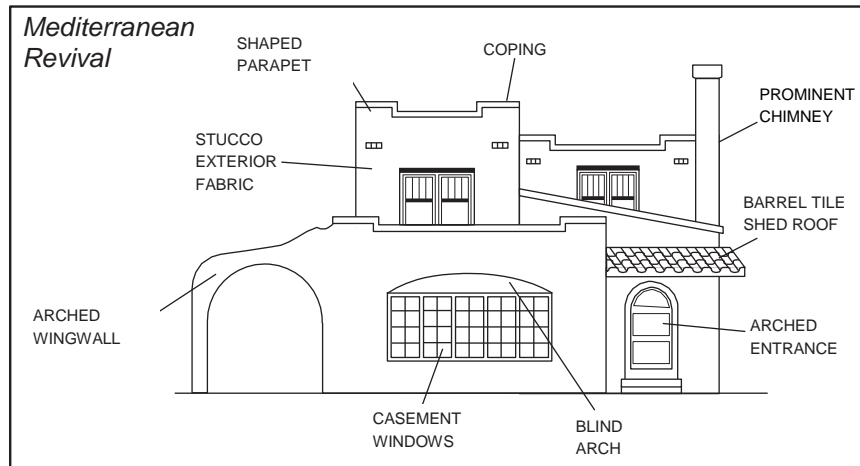

The Mediterranean Revival style was not limited to Florida, but finds examples across the country, notably in California, Arizona and Texas. Contemporary architectural historians have differed in their choice of names for this Florida phenomenon, but all agree that Florida's Mediterranean Revival demonstrates an eclecticism that capitalizes on a number of design traditions.

In an article entitled "The New Mediterranean Architecture of Florida" by Matlack Price, published in the June 1925 edition of *House Beautiful*, the author describes the style that became the pre-eminent choice for buildings in Florida during the Land Boom of the 1920s. He begins by describing the Spanish-derivative forms in California, specifically refers to Mission Revival, and then continues to Arizona and Texas to describe Pueblo designs.



*Mediterranean Revival commercial building*

Virginia and Lee McAlester in their book, *A Field Guide to American Architecture*, begin their explanation with a section entitled "Eclectic Houses 1880–1940." They then

name variants of what has been generically called Mediterranean Revival. They include the following styles: Italian Renaissance, Mission, Spanish Eclectic, Monterey, and Pueblo Revival.

Professor David Gebhard, in his article for the *Journal of the Society of Architectural Historians* entitled "The Spanish Colonial Revival in Southern California," provides a simpler explanation. He states that in the broader application, the style is best called Spanish Colonial Revival. He then notes that the Spanish Colonial Revival had two distinctive variations, first the Mission Revival and then later the Mediterranean Revival.



*Mediterranean Revival residence*

In South Florida, historians are comfortable with the stylistic identity of Mediterranean Revival as a commingling of inspiration from the countries that border the Mediterranean Sea, including Spain, Italy and the Northern coast of Africa, with its rich Moorish heritage.

### General Characteristics:

- Plan shape: asymmetrical or U-shaped to create a courtyard
- Building material: generally masonry
- Exterior surface treatment: stucco (smooth or textured)
- Roof type: combination; gable; hipped; shed; pyramidal
- Height: one to two-and-one-half stories
- Window type: casement
- Other:
  - Broad areas of uninterrupted surfaces with ornament concentrated around windows and doorways
  - Cast stone or concrete ornament concentrated around windows and doors
  - Covered open areas created by arcades and loggias
  - Porte cochères attached on the side of the residence
  - Juxtaposition of one and two stories
  - Wrought iron decorative ornament employed as grilles
  - Use of towers, especially at corners
  - Barrel tile roof coverings



## Monterey (1925–1940)

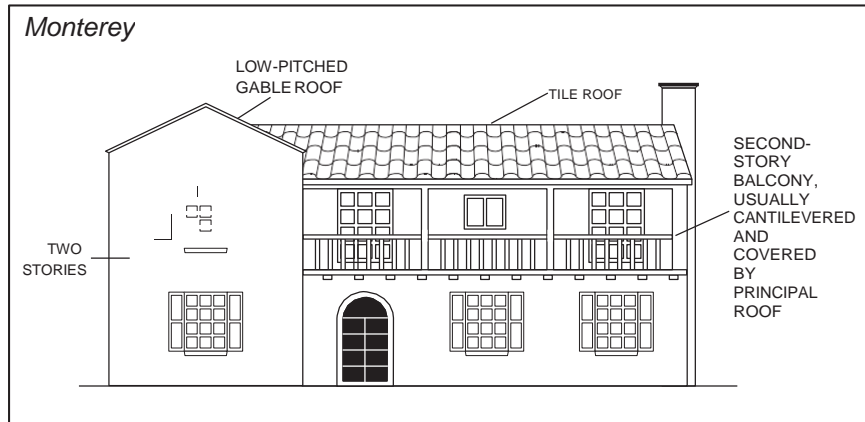

This residential type is named for the colonial capitol of California during the Spanish occupation. Its beginnings can be traced to Boston merchant Thomas Larkin, who relocated to Monterey and built a house that was a cross between the Colonial houses in New England and the Spanish Colonial houses in California. The Monterey style was popular in Florida from the 1930s through the 1950s. While the style was derived from the Spanish Colonial houses of Northern California, they typically combined Spanish Eclectic elements with Colonial Revival details. Earlier examples tend to favor Spanish Eclectic detailing, while later examples tend to favor Colonial Revival detailing. The principal feature of the Monterey style is a second story porch that cantilevers over the first floor and is covered by the principal roof. The low-pitched roof shapes range from gabled to hipped and are covered with concrete tiles. Shutters commonly flank the windows. Detailing includes exposed rafter tails and vents.

### General Characteristics:

- Plan shape: “L”
- Building material: frame; masonry
- Exterior surface treatment: combination of exterior cladding materials

- Roof type: low-pitched gable covering cantilevered second-story balcony
- Height: two stories
- Window type: wood frame; double-hung sash; casement
- Other:
  - Tile or shingle roof coverings
  - Exposed rafter tails and vents
  - Shutters

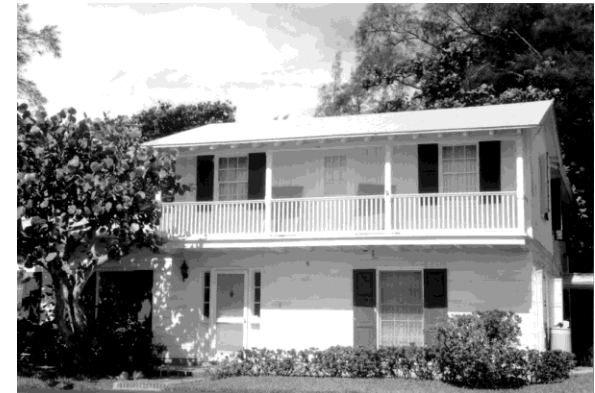

*Monterey style residence*



*Monterey style residence*

## Art Deco (1925–1940)

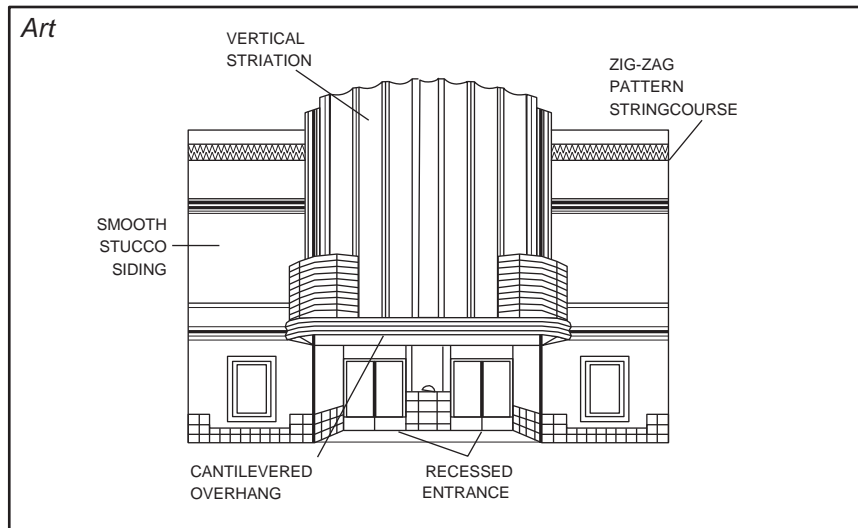

Art Deco is considered one of the first of the “modern” styles, as it is a conscientious move away from the historicist styles to a new expression that sought to complement the machine age. The style is a contemporary of the International Style. While created for the Paris *Exposition Internationale des Arts Decoratifs and Industriels Moderne*, a show held in 1925, the style reached its zenith in the United States in the 1930s. Art Deco is not just a style of architecture, but is more a style of decoration that was used in furniture, jewelry, clothing and handicrafts. Industrial designers used the motifs to design streamlined cars, trains and even kitchen appliances.

Art Deco was popular from the 1920s through the 1940s and had a definite tropical flavor. Characteristic features of the style include a stepped or setback façade, strong vertical emphasis, and low-relief ornamentation with stylized motifs. Verticality is achieved through towers, window spandrels, and vertical projections, such as futuristic masts or pinnacles. These motifs often exhibit abstract geometric designs, such as zigzags or chevrons, or organic designs, such as sunbursts or fountains. In architecture, the style was not as common for single-family homes, but

was extremely popular for apartments and commercial buildings. Pastel colors were added when the renaissance of Art Deco began in the 1980s and were not original.

### General Characteristics:

- Plan shape: asymmetrical
- Building material: generally masonry
- Exterior surface treatment: stucco (smooth or textured)
- Roof type: flat
- Height: one to three stories
- Window type: casement; sash; awning
- Other:
  - Smooth masonry surfaces incorporating glass block
  - Horizontal bands of ornamentation; sometimes as projecting lintels or “eyebrows”
  - Zigzags, chevrons, geometric and stylized decorative motifs used as ornament (sometimes polychromed)
  - Cylindrical towers or other projections above the roofline to add vertical emphasis



*Art Deco style commercial*

## Art Moderne/Streamline Moderne (1930–1945)

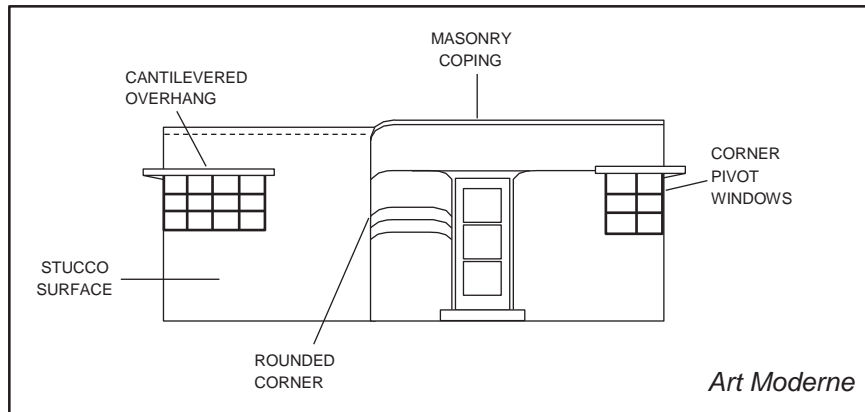

Both of these styles are sub-types of Art Deco and are also considered products of the modern movement in architecture. Generally, Art Moderne, or Streamline Moderne, is considered to come after the introduction of Art Deco, although they share many of the same characteristics. Art Moderne reflects the early twentieth century excitement over technological advancements, high speed transportation, and innovative new construction techniques.

During the 1930s and 1940s, the Art Moderne style was one of the most popular styles found throughout Florida. Characteristic features include smooth wall surfaces, flat roofs, asymmetrical plans, and a horizontal emphasis. Portholes, pipe railing, wave motifs, prowlike projections and other nautical references are sometimes used. Materials such as glass block, mirrored or stainless steel panels, and aluminum doors and window trim often are used. Grooves, bands (sometimes called “racing stripes”), and balustrades contribute to the horizontality of the buildings, as does streamlining. Streamlining is seen in the use of rounded corners, bands of windows, which continue around corners and have concrete overhangs or “eyebrows” above them.

### General Characteristics:

- Plan shape: symmetrical; asymmetrical
- Building material: masonry
- Exterior surface treatment: smooth wall surfaces
- Roof type: flat, with a parapet
- Height: one to three stories
- Window type: fixed; glass block; awning; jalousie
- Other:
  - Rounded corners
  - Horizontal grooves at the corners
  - Horizontal balustrade elements
  - Coping at the roof line



*Art Moderne commercial building*



*Entrance detail on an Art Moderne residence*

## Contemporary (1950–1970)

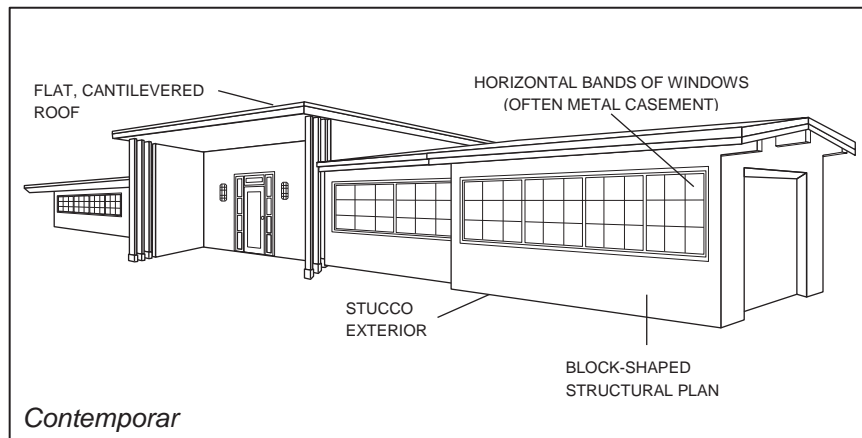

Contemporary style houses were constructed from circa 1950 until 1970 and fall in the category of Modern architecture, in which form follows function. There are two subtypes based on roof form: flat and gable. The flat roof subtype is based on the earlier International style and is referred to as the American International. The International style is reflected through the flat roof, rectangular forms, and lack of detail. However, Contemporary houses in the flat roof subtype often use a multiplicity of materials, a trend that was popular in the 1950s; International style had stark, often white, surfaces covered with a single material. The gabled subtype recalls the earlier Craftsman and Prairie styles. Commonly, they have overhanging eaves and exposed roof beams; heavy piers may support the gables. Like their flat-roofed counterparts, a variety of building materials often are used and detailing is kept to a minimum. An irregular plan, flat roof, cantilevered, overhanging roof eaves, bands of windows, and the use of metal characterize contemporary residences in Delray Beach.

### General Characteristics:

- Plan shape: symmetrical; irregular
- Building material: concrete; glass; steel
- Exterior surface treatment: stucco; multiple materials
- Roof type: flat; frequently cantilevered
- Height: one to two stories
- Window type: ribbon; corner windows; metal casement
- Other:
  - Continuous bands of windows that create a horizontal emphasis
  - Mechanical elements (e.g., elevator shafts, air-conditioning compressors) often highly visible



*Gable roof on a Contemporary style residence in Delray Beach*



*Contemporary style residence in Delray Beach reflecting the flat-roof style*



## Ranch (1935–1975)



This style originated in California during the mid-1930s and continued in popularity through the 1970s. The popularity of this style is attributed to the availability of the automobile, which allowed travel beyond streetcar, bus and train routes into the suburbs outside the city core where land was still relatively inexpensive. As a result, the plans almost always included an attached garage, usually on the primary elevation. Houses that once had been built on compact lots, now were built on larger parcels that allowed a one-story residence to take on sprawling proportions.

### **General Characteristics:**

- Plan shape: irregular
- Building material: frame; masonry
- Exterior surface treatment: wood cladding; stucco
- Roof type: low-pitched hip or gable
- Height: one story
- Window type: awning; fixed; jalousie
- Other:
  - Attached one- or two-bay garage carport on front façade
  - Horizontal design emphasis
  - Concrete tile or shingle roof covering

Three examples of Ranch style residences





## SECTION V. DESIGN PRINCIPLES AND RECOMMENDED REHABILITATION TREATMENTS

### DESIGN REVIEW BY THE DELRAY BEACH HISTORIC PRESERVATION BOARD

To evaluate Certificate of Appropriateness applications, the Board uses the principles established by *The Secretary of the Interior's Standards for Rehabilitation*, produced by the National Park Service in 1977 (revised 1990). The standards provide a useful framework with which to measure a successful project, but are not intended to address every conceivable situation. The 10 standards are printed in Appendix A.

***In each of the following rehabilitative treatments discussed, the applicable Secretary of the Interior's Standard will precede the section.***

### EXTERIOR SURFACES AND MATERIALS

To convey the authenticity and the patina acquired by age, nothing can replace the value of the original materials, finishes and ornament that were originally used in the construction of historic properties.

- *Deteriorated historic features should always be repaired rather than replaced, unless the material no longer retains its original features or has suffered such physical degradation that repairs are no longer a viable option.*
- *The original siding conveys a number of qualities, such as profile, patina and shadow, that often are not conveyed when mass-produced materials are used.*
- *When details have been covered over, every effort should be made to reveal and retain what may be left.*



*The exterior of this residence is a combination of stucco and painted brick.*



*This building has stucco on the first story and wood siding on the second story.*

## Wood Siding

Wood frame construction was popular in Delray Beach largely because of its ready availability and relative economy. The legendary Dade County Pine, that was once plentiful in South Florida, was impervious to termites and a favorite local building material. Wood siding is an exterior wall covering composed of wood boards that are fastened to the structural frame of the building. Frequently the siding is used as a decorative feature and different

The most common types of wood siding are:

- **Beveled, Clapboard, Lap:** Horizontal strips of wood that are slightly
- **Board and Batten:** Vertical boards with battens (narrow vertical strips) placed over the joints between the boards.
- **Drop, Novelty, Rustic:** Narrow strips of wood pieced together; in many cases the upper portion of each board is concave.
- **Tongue and Groove:** Boards that fit tightly together as the jutting edge of one board fits into the grooved end of another board. **Shiplap** siding is virtually identical.

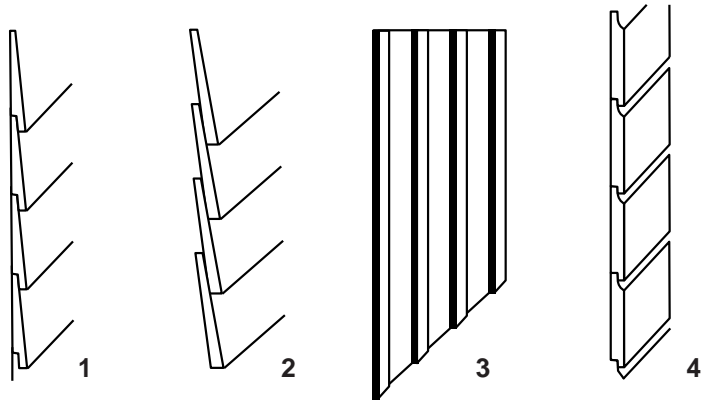

Wood Siding Types: (1) Dolly Vardenor Beveled Siding, (2) Clapboard or Weatherboard, (3) Board and Batten Siding, and (4) Drop Siding

There are now commercially available fiber-cement manufactured exterior sidings that simulate the look of wood siding. *This material may be authorized for use on a case-by-case basis, but is generally discouraged.*

### Rehabilitation Treatments

#### Applicable Secretary of the Interior's Standard(s):

*The historic character of a property will be retained and preserved. The removal of distinctive materials, or alteration of features, spaces and spatial relationships that characterize a property will be avoided.*

*Deteriorated historic features will be repaired rather than replaced. When the severity of deterioration requires replacement of a distinctive feature, the new feature will match the old in design, color, texture, and where possible, materials. Replacement of missing features will be substantiated by documentary and physical evidence.*

#### Recommended:

- Retain full width of the corner and sill when installing siding. Horizontal wooden clapboards should overlap one another and cast a shadow.
- Retain all trim elements.
- Provide proper drainage so water does not stand on flat horizontal surfaces or accumulate in decorative features.
- Apply preservatives or consolidators to wood features such as beam ends or outriggers that are exposed to decay hazards and that are traditionally left unpainted.
- Retain paint coatings that protect wood from moisture and light.
- Remove paint using the least abrasive means possible, by hand scraping or sanding for example.

- Use chemical strippers to supplement other methods. Detachable wooden elements, shutters, doors or columns may be chemically dip-stripped with proper safeguards.
- Repair wood features by patching, piecing-in, consolidating, or otherwise reinforcing the wood.
- Repairs may include limited replacement with compatible materials for those extensively deteriorated or missing parts or features.
- Replacements should be designed using the existing physical evidence as the pattern so that brackets, moldings or sections of siding, for example, are based on the original details. That evidence may be present elsewhere on the building or documented through historic photographs or building plans.

#### **Not Recommended:**

- *Unnecessarily* removing a major portion of wood from a façade instead of replacing or repairing the deteriorated wood.
- Stripping painted surfaces to bare wood to achieve a “natural” effect.
- Failing to identify the underlying cause(s) of wood deterioration. Conditions such as faulty flashing, leaking gutters, cracks and holes in the siding, deteriorated caulking in joints and seams, plant material and weeds, insect and fungus infestation are some root causes of wood deterioration. Without the treatment of the cause, the destruction will continue.
- Creating a false architectural appearance by adding or eliminating detail(s).
- Applying synthetic materials that conceal building materials. Sidings, such as vinyl or aluminum, can mask the advance of termite infestation or wood rot. Severe moisture problems may occur because siding traps moisture in the wall cavity.
- Painting surfaces that were originally natural.



*Example of hexagonal wood shingles*



*An example of weatherboard siding*



*Board and batten siding*



## Masonry (Concrete Block, Brick, Hollow Clay Tile, Stucco)



Stucco exterior

Concrete is made from cement, aggregates and water. While it is in a fluid state, it can be poured into forms and, when hardened, has a durability similar to stone. Concrete block was one of the preferred materials for construction, particularly in the Mediterranean Revival and Mission buildings of the 1920s and 1930s. Concrete also was used to create decorative ornament, cast in shields, medallions and a variety of forms. The cast concrete is sometimes called cast stone.

Brick became common in Florida as a masonry material after the Civil War, when the railroads expanded into the state. Many commercial buildings were then built of brick because of its fire resistance. In the 1920s, brick often was used as a veneer in combination with masonry or frame construction. With brick, the color varies according to the sand and firing technique utilized. Yellow brick was particularly popular in South Florida during the 1920s and 1930s.

Hollow clay tiles were also a popular building material. The clay was baked to form structural tile units that were hollow inside. These tiles were used for self-supporting walls and partitions.

These structural members often are covered with stucco. Stucco is a durable finish comprised of cement, sand and lime that is applied while still wet to a wire metal



Textured stucco exterior on a Mission style house

mesh, lathe or wood strips. Because the stucco is pliable, it lends itself to texturing. Depending on the effect desired or the type of architectural design, the stucco may be applied to achieve a smooth texture or a variety of effects when troweled on to create a rough texture. The rough textured stucco is typically a characteristic of Mission and Mediterranean Revival architecture, while the almost machined quality of smooth stucco is a hallmark of Art Deco and Art Moderne styles.

### Rehabilitation Treatments

#### **Applicable Secretary of the Interior's Standard(s):**

*The historic character of a property will be retained and preserved. The removal of distinctive materials, or alteration of features, spaces and spatial relationships that characterize a property will be avoided.*

*Deteriorated historic features will be repaired rather than replaced. When the severity of deterioration requires replacement of a distinctive feature, the new feature will match the old in design, color, texture, and where possible, materials. Replacement of missing features will be substantiated by documentary and physical evidence.*

#### **Recommended:**

- Ensure that the material/surface is moisture-free before repointing.
- Provide proper drainage so that water does not stand on flat, horizontal surfaces or accumulate in curved decorative features.
- Clean with low-pressure water (40–60 psi) and use natural bristle brushes and a mild detergent with a neutral pH balance.
- Remove damaged or deteriorated paint only to the next sound layer.
- Repoint mortar joints so that the new mortar matches the color,

width of original joint, texture and density of the existing mortar in color and size

- Repoint with a Portland cement that has the same consistency as the original mortar.
- To determine any adverse chemical reactions with the use of cleansers, test a small area in an inconspicuous place prior to continuing.

**The most important rule: Always create a test patch so you can examine the result before the final work proceeds.**

**Not Recommended:**

- Mixing types of materials, unless it can be documented.
- The use of artificial materials, such as PermaStone, stone and wood veneers, or vinyl siding, should not be used.
- Replacing when repairing would be sufficient.
- Cleaning with abrasive methods, in particular sand blasting that erodes surfaces and actually accelerates deterioration through water intrusion.
- Cleaning with a high-pressure water blast, which may damage the mortar joints or the masonry.
- Covering any masonry with stucco that was not originally covered.



*A combination of brick and stucco on the exterior of a Delray Beach residence*



*This commercial building in Delray Beach was constructed of concrete block.*



## Paint

Paint is essentially a protective covering that is applied to both frame and masonry surfaces. The choice of paint color for the *exterior* of a historic property is a combination of personal taste, and in historic districts, consideration as to how that paint color will affect the character of the neighborhood.

### ***Rehabilitation Treatments***

**Applicable Secretary of the Interior's Standard(s):**

***Chemical or physical treatments, if appropriate, will be undertaken using the gentlest means possible. Treatments that cause damage to historic materials will not be used.***

### **Recommended:**

- The combination of colors selected for wall mass, trim and decorative elements should be complimentary and should avoid disharmony or color clashes.
- Paint should never be used to cover natural elements, such as stone, wood or brick, unless previously documented.
- Before painting, make all necessary roof, siding, and surface repairs.
- All deteriorated wood should be repaired or replaced in-kind.
- Check window trims, seal holes, caulk cracks, and treat for wood fungus.
- Use commercial stripping compounds, electric paint removers, wire brushes and putty knives to remove loose paint.
- Wear a painter's mask and gloves to avoid inhaling or absorbing paint dust, and paint in a well-ventilated area.
- Wash masonry walls with a neutral pH cleaning compound for a better adhering surface for paint.

Certain architectural styles lend themselves to different color treatments. For example, Mediterranean Revival designs are generally associated with warm colors in which the dominant hues are reds and yellows. Cool colors are at the opposite end of the color wheel, and blues and greens are dominant. These cool colors, when used in a lighter intensity, create the pastels that have frequently been associated with Art Deco designs. Paint color changes must be administratively or Board approved. An application for a Certificate of Appropriateness must be completed, as well.

**Remember: lead-based paint is toxic!! Always use protective gloves, clothing and masks when working with these materials!!**

## FOUNDATIONS

Foundations are defined as those structural supports, above or below grade, that support the weight of a building. Rusticated masonry blocks, bricks, concrete slab and continuous piers are the most common foundation types for historic buildings. The rehabilitation process should always consider a building's structural condition. A visual inspection under the structure will help to determine the structural condition of the foundation. Early Frame Vernacular and Bungalow styles were constructed on stone or brick piers supported by wood framing. In bungalows, the foundation piers are an important character-defining element. Typically, Mission, Mediterranean Revival and Streamline styles were constructed with poured-in-place, reinforced concrete supports with solid perimeter foundation walls. Some foundations allow for basements and crawl spaces.

### Rehabilitation Treatments

**Applicable Secretary of the Interior's Standard(s):**

*The historic character of a property will be retained and preserved. The removal of distinctive materials, or alteration of features, spaces and spatial relationships that characterize a property will be avoided.*

**Recommended:**

- Exposed, unpainted natural stone should be retained.
- Plantings should not touch the foundation, but kept a short distance away.
- Lattice or basket-weave wood ventilators should be placed between piers. The removal of these devices accelerates dampness, termite/insect decay and pest or rodent infiltration.
- Portland cement mixes have not changed and, if repairs are necessary, a mason should be able to repoint in a similar size, material, density, profile and color.

- The area around the foundation should always slope away from the building to insure proper drainage.



Example of a brick pier foundation

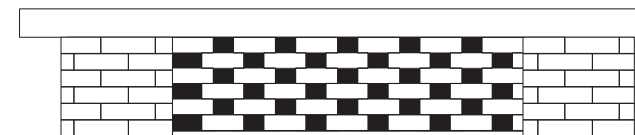

Appropriate pierced brick

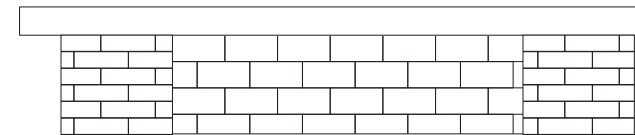

Inappropriate concrete brick

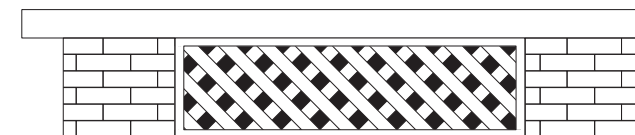

Appropriate lattice

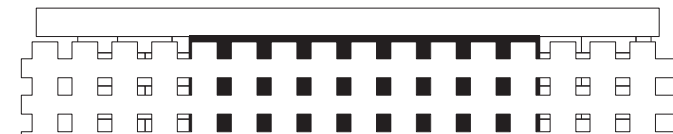

Inappropriate wood slats

Examples of appropriate and inappropriate foundation infill treatments

## ROOFS

Because they have a limited useful life, many roofs have been replaced over time. Sometimes the materials used in the replacement are not original to the building. Every effort should be made to identify the original roofing material and to use that material in the event a non-historic roof is replaced.

Roof forms (e.g., flat, gabled, hipped) are integral to a building's design, and are highly important as a character-defining feature. For example, Mission style buildings have flat roofs, while bungalows almost always have a gabled or hipped roof shape. The materials that cover the roof also are defining characteristics that greatly contribute to the identity of a property. Wood shingle, clay barrel or mission tile, standing seam metal, and asphalt shingle are common roofing materials in Delray Beach.

Roof overhangs or eaves provide shade, protect doorways, and the shadows cast create a visual effect. Outrigger beams (sometimes called rafter tails) are decorative elements that further contribute to the intrinsic character of a historic property.

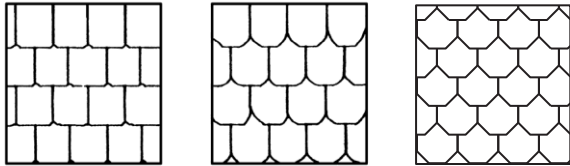

Illustration of square, fishscale and octagonal roof shingles

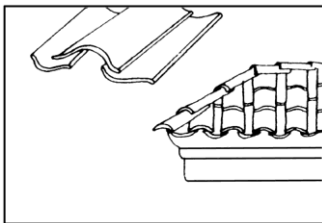

Illustration of Mission, or barrel, tiles



Example of irregular style roof shingles

## Rehabilitation Treatments

### Applicable Secretary of the Interior's Standard(s):

*The historic character of a property will be retained and preserved. The removal of distinctive materials or alteration of features, spaces and spatial relationships that characterize a property will be avoided.*

*Changes to a property that have acquired historic significance in their own right will be retained and preserved.*

*Distinctive materials, features, finishes and construction techniques or examples of craftsmanship that characterize a property will be preserved.*

### Recommended:

- If damaged, protect a leaking roof with plywood and building paper until it can be properly repaired.
- Preserve the roof's shape, decorative features, and materials, as well as its patterning, color, and size.
- Maintain waterspouts and gutters and replace deteriorated flashing. Sheathing should be checked to prevent condensation and water penetration, and to insure protection from insect infestation.
- Repair a roof by reinforcing the historic materials. Repairs will generally include limited replacement with in-kind materials or a suitable replacement. (Suitable is defined as matching, as accurately as possible, the composition, size, shape, color and texture of the original material.)
- Missing parts of roofs, such as cupola louvers, dentils, and dormers, should be replaced using the surviving examples as a guide to the new work.

- Install mechanical, electronic or service equipment so that they are as inconspicuous as possible and, when installing, avoid damaging or obscuring the view to character-defining features such as dormers and cupolas.

**Not Recommended:**

- Changing the basic character of a roof by adding inappropriate features such as dormers, widow’s walks, vents, skylights, air-conditioners and solar collectors that are visible from the public right-of-way.
- Failing to properly clean and maintain gutters and downspouts so that water and debris collects, which may cause damage to roof fasteners, sheathing and the underlying structure.
- When the scope of the work involves a repair, avoid removing more of the roof than is necessary and reroofing with a new material to achieve an “improved” appearance.
- Stripping the roof of its historic material (i.e., slate, clay tile, wood or architectural metal).

**Roof Materials:**

- In the course of its long history, roofing materials in Delray Beach included standing seam metal roofs.
- Introduction of new roof materials not traditionally used in Delray Beach (such as copper, slate or thatch) is not encouraged; however, alternate materials may be authorized on a case-by-case basis.



*A standing seam metal, cross-hip roof*



*This Mission style house combines a gable roof of barrel tiles and flat roof. (Note that the chimney has elements of both the exterior surface and the roof.)*

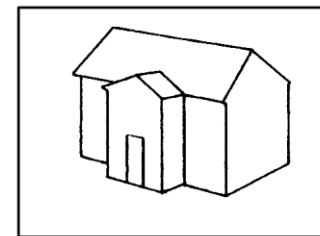

1

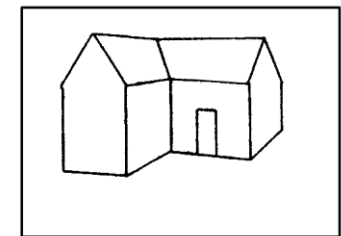

2

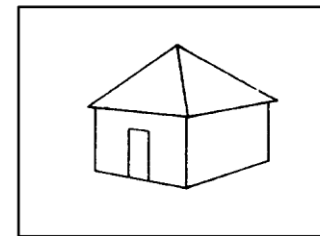

3

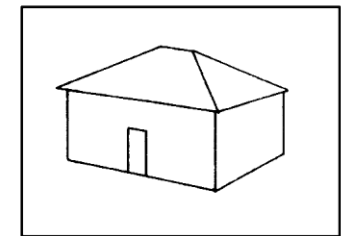

4

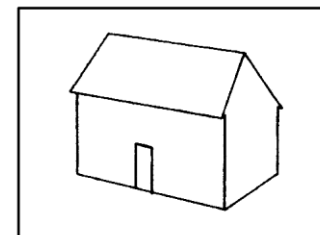

5

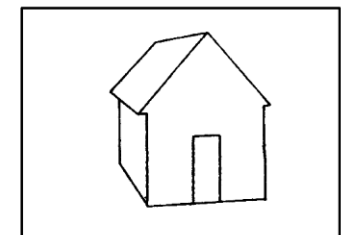

6

**Examples of common roof types:** 1. Center Gable, 2. Cross Gable, 3. Pyramidal, 4. Simple Hip, 5. Side Gable, 6. Front Gable

## CHIMNEYS

Traditionally, fireplaces were the focal point of a home where families would congregate and use the open fire for both cooking and as a source of heat. Fireplace chimneys are another important character-defining feature of a building and may project from a roof, concealing the shaft, or be attached to an exterior wall and extend from the ground floor past the roof.

In many early homes, the brick chimneys were left unpainted. Later, chimney exteriors received the same surface treatment as the exterior walls. In many of the Mediterranean Revival residences, the chimneys received an ornamental cap that added another point of interest to the design.

### *Rehabilitation Treatments*

#### **Applicable Secretary of the Interior's Standard(s):**

*The historic character of a property will be retained and preserved. The removal of distinctive materials or alteration of features, spaces and spatial relationships that characterize a property will be avoided.*

*Chemical or physical treatments, if appropriate, will be undertaken using the gentlest means possible. Treatments that cause damage to historic materials will not be used.*

*Each property will be recognized as a physical record of its time, place and use. Changes that create a false sense of historical development, such as adding conjectural features of elements from other historic properties, will not be undertaken.*

#### **Recommended:**

- Retain the chimney as it existed historically; avoid painting or otherwise altering the exterior materials.
- If the chimney was painted in the past, repainting may be appropriate.

- If detail has been lost, it may be replaced based on existing documentary evidence.
- Maintain flashing and protect against water infiltration.

#### **Not Recommended:**

- Adding conjectural features or ornament that was not present historically.
- Painting chimney surfaces that were never painted.
- Removing or relocating a chimney.
- Introducing new material.



*The brick chimney on this residence is*



*This chimney was stuccoed to match the surface treatment of the house.*



## WINDOWS

Windows are a preeminent character-defining feature of a building. Their placement, design and materials serve to articulate and give definition to the design-specific styles and periods of time. For example: in Bungalows, there are usually multiple panes in the upper window sash, and in Mediterranean Revival designs, windows are frequently arched.

Windows are comprised of a number of parts which each contribute to the appearance. The sash of the window is its framework, which may be operable or fixed, and which might slide in a vertical plane (as in a double-hung window) or be pivoted (as in a casement window). The muntins are secondary framing members that hold the panes within a window; a mullion is a vertical member that separates panes (or lights) and frequently adds support.

A single-hung sash window is a vertically sliding window where one of the sashes (usually the lower) may be opened and the other sash is fixed. A double-hung sash window is a window that has two vertically sliding sashes that may be used to open either the upper or lower sash of the window.

When windows cannot be repaired, any replacement design should take into consideration the features of the original, including:

- Trim detail;
- Material;
- Size and shape of frame and opening;
- Reveal or setback of the window from the wall plane;
- Light configuration;
- Whether the horizontal line of the sash is on the same, or different, plane;
- The color and reflective qualities of the glass; and
- The muntin and mullion profiles and their configuration.

When new windows are required, *their replacement with the original material is always most desirable*. However, the Historic Preservation Board will consider other materials or cladding on a case-by-case basis, provided that the new windows match the originals in their profile, configuration and any other character-defining feature(s).

In pre–World War II designs, windows were most frequently either wooden or metal single- or double-hung or a casement type. After the war, jalousie and awning (sometimes called hopper) window types became more prevalent.

### **Rehabilitation Treatments**

#### **Applicable Secretary of the Interior's Standard(s):**

***The historic character of a property will be retained and preserved. The removal of distinctive materials or alteration of features, spaces and spatial relationships that characterize a property will be avoided.***

***Each property will be recognized as a physical record of its time, place and use. Changes that create a false sense of historical development, such as adding conjectural features of elements from other historic properties, will not be undertaken.***

***Deteriorated historic features will be repaired rather than replaced. When the severity of deterioration requires replacement of a distinctive feature, the new feature will match the old in design, color, texture, and where possible, materials. Replacement of missing features will be substantiated by documentary and physical evidence.***

#### ***For new construction:***

***New additions, exterior alterations, or related new construction will not destroy historic materials, features, and spatial relationships that characterize the property. The new work shall be differentiated from the old and will be compatible with the historic materials, features, size, scale and proportion, and massing to protect the integrity of the property and its environment.***

**Recommended:**

- Retain distinctive windows which feature a sash, muntins, glazing, sills, heads, hood molds, paneled or decorated jambs and moldings, and shutters and blinds.
- Maintain with periodic cleaning, rust removal, paint removal, and reapplication of protective coating systems. Recaulk and replace weather stripping, making windows watertight and improving thermal efficiency.
- Repair frames and sash by patching, splicing, consolidating or otherwise reinforcing and replacing in kind. Damaged parts may sometimes be replaced from other salvaged historic windows.

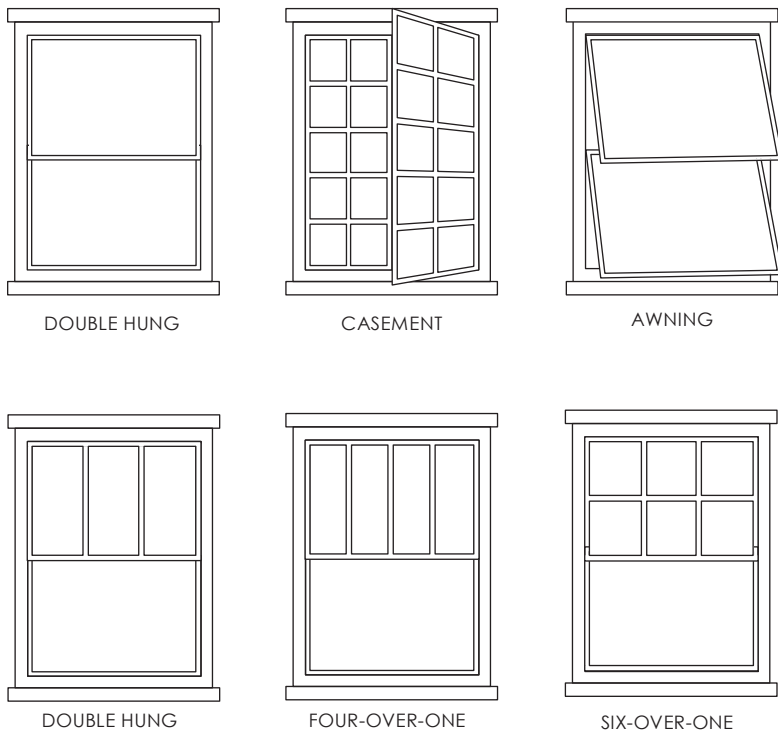

*Casement windows on a Mediterranean Revival residence*

- Design and install new windows when the historic windows are completely missing.
- New windows in additions or exposed party walls should be compatible with the overall design, but not necessarily duplicate the fenestration pattern and detailing of a character-defining elevation.
- In double- or single-hung windows, retain window weights when possible.

**Not Recommended:**

- Cutting new openings, altering existing openings, blocking windows, and installing a replacement sash that does not fit the window.
- Changing the historic appearance through inappropriate design materials or adding a finish or color that changes the sash, depth of reveal, the reflectivity, or the appearance of the frame.
- Replacing viable windows rather than maintaining the original. Bronze, black frame, or tinted windows are not preferred choices.
- New Construction: In selecting windows for an infill design in a historic district, flat “snap in” muntins **should not be used** to simulate the division of window panes. Any such divisions should be created with muntins that create a true profile.

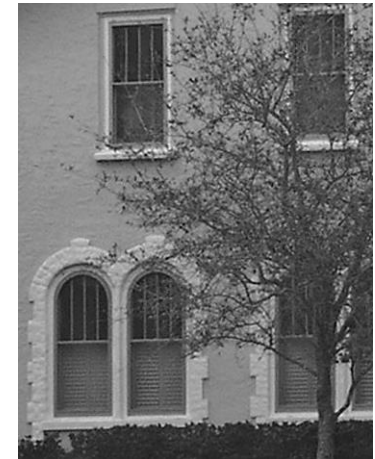

*Flat and arched double-hung sash windows on a Mediterranean Revival house*

## DECORATIVE SHUTTERS

Shutters originally were designed for the inside of the home, to cover the lower portion of a window where no glass was installed. During the Victorian era, shutters were moved to the outside of the house to protect the home and windows from weather. By the late nineteenth century, shutters began to be used more for decoration than protection. They can be made of wood, vinyl, aluminum or composite fiberglass. Styles include louvered, raised panel, board and batten and Bahama. In coastal South Florida, louvered shutters have been used to block the afternoon sun, while still allowing circulation of the sea breezes, and to provide hurricane protection. Shutters were sometimes features of Colonial Revival and Minimal Traditional buildings, and Bahama shutters were sometimes incorporated into Bungalow designs. Board and batten shutters often are found on turn-of-the-century Vernacular buildings.

### Rehabilitation Treatments

**Applicable Secretary of the Interior's Standard(s):**

*Each property will be recognized as a physical record of its time, place and use. Changes that create a false sense of historical development, such as adding conjectural features of elements from other historic properties, will not be undertaken.*

*Deteriorated historic features will be repaired rather than replaced. When the severity of deterioration requires replacement of a distinctive feature, the new feature will match the old in design, color, texture, and where possible, materials. Replacement of missing features will be substantiated by documentary and physical evidence.*

**Recommended:**

- Shutters should be operable or appear to be operable.
- Shutters should be designed so they measure the full height and one-half the width of the window frames.



Shutter dog on Colonial style shutter

- “Shutter dog” hardware should be used to enhance the appearance that the shutters are operable.
  - Shutters should be attached to the window casing rather than the exterior finish material.
- Shutter details should compliment the construction material and architectural style of the property on which they are applied. For example, wooden raised panel shutters or board and batten shutters are frequently used in wood frame houses.

Illustration of one

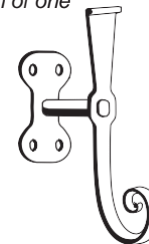

An example of properly installed shutters on a

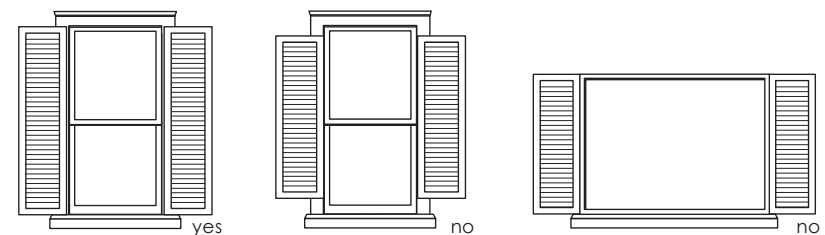

Examples of proper and improper shutter installation

## DECORATIVE AWNINGS

Canvas awnings were frequently used in Florida as protection from the sun and elements. In addition to their functional purpose, awnings frequently introduced color, and were part of the decorative effect. They often were featured on Colonial Revival, Spanish and Bungalow style homes. Awnings can be made of canvas, vinyl or metal. They can be dome or shed style. Decorative awnings are considered a reversible treatment and, as such, are permitted on both contributing and non-contributing buildings upon review and approval.

### *Rehabilitation Treatments*

**Applicable Secretary of the Interior's Standard(s):**

***Each property will be recognized as a physical record of its time, place and use. Changes that create a false sense of historical development, such as adding conjectural features of elements from other historic properties, will not be undertaken.***

- Awnings should follow the lines of the window opening. For example, in a Mediterranean Revival style building, a round arched window should employ either a round or bell-shaped window. For flat-headed windows, angled rectangular are most appropriate.
- Awnings that obscure significant detail should not be used.
- The color and design of the awning should compliment the structure on which it is attached.
- Awnings should be installed in such a way that they do not damage the structure to which they are attached, even if they are removed.



*A shed-style awning on a Delray Beach residence*



*Decorative dome-style awnings on a Mission style residence in Delray Beach*



## SECTION VI: NEW CONSTRUCTION

### APPLICABLE SECRETARY OF THE INTERIOR'S STANDARDS

***New additions, exterior alterations, or related new construction shall not destroy historic materials that characterize the property. The new work shall be differentiated from the old and shall be compatible with the massing, size, scale and architectural features to protect the historic integrity of the property.***

***New additions, and adjacent or related new construction shall be undertaken in such a manner that if removed in the future, the essential form and integrity of the historic property and its environment would be unimpaired.***

New construction refers to new buildings, structures (outbuildings) or additions to extant contributing or non-contributing buildings that are constructed on vacant lots within a historic district, or on an individually listed historic site. When a new building is constructed to fill in the gaps of a streetscape in a historic district, the new building is referred to as "infill" construction.

All infill must be compatible with the surrounding buildings and yet must be *differentiated* from the historic building stock. To be successful, this new design should reflect the significant themes in its environment and will include attention to:

- Height
- Materials
- Roof form
- Massing
- Set-backs
- Rhythm of openings (i.e., doors and windows)
- Relationships of solids and voids
- Scale
- Orientation

New construction, including additions to historic resources, must meet the current Florida Building Code and the current zoning requirements that include setbacks, lot area, frontage, etc.

The Secretary of the Interior's Standards advise that replication and mimicry are unacceptable approaches to new design. That concept may seem unusual, as many think that imitation *is* the sincerest form of flattery.

*History is a continuum, where today's contributions will at some time in the future, be judged for their impact. Without a clear distinction between what is historic and what is contemporary, development patterns become blurred and the outcome can create a false sense of historical development.* The guidelines allow for a wide range of interpretation. Some communities that apply these standards have taken a very conservative approach in handling the design for new additions/construction. They have maintained that by the subtle differentiation of surface textures, or the simplification or stylization of ornament, that a distinction can be made and still be in compliance with the intent of the Standards.

For additional information, or if you have questions, feel free to check with the city's Historic Preservation Officer.

### Additions

Historic preservation recognizes the evolution of a property, and subsequent owners of historic resources are part of that evolutionary process. During the course of time, frequently additions have been made to historic properties because of practical need and changing economic status.

In the design process for new additions, the following guidelines should be observed:

- Locate an addition as inconspicuously as possible, usually to the rear or least public side of a building.

- Additions or accessory structures should not be located in front of the established front plane of a historic building.
- Avoid obscuring or destroying characteristic features of the original building; the loss of historic fabric should be minimal.
- When possible, design and construct the addition so that the basic form and character of the historic building would remain intact if the addition were ever removed.
- For buildings where additional height is allowed, stepping back the upper stories may help to minimize the difference as viewed from the street.
- In a historic district, consider the surrounding buildings and the compatibility of the addition in terms of size, scale, materials, mass and roof form.
- Do not introduce a new architectural style, or too closely mimic the style of the existing building. Additions should be simply and cleanly designed and NOT attempt to replicate the original design.
- The design elements for new construction should be continued on all sides of the building, so as to avoid a “stage-set” appearance.
- Insure that the addition is secondary and subordinate to the main mass of the historic building. Additions that overwhelm the original building are not an acceptable solution.

### **Infill Buildings**

All new construction should complement the historic architecture of the district. The relationship of that new construction adjacent to the significant historic resources can either enhance or detract from the historic setting of the district. New construction (infill) should not create a false sense of historical development by utilizing conjectural features of stylistic elements taken from other buildings.



*An example of appropriate infill construction in the Del-Ida Park Historic District*

## RECOMMENDED APPROACHES TO NEW CONSTRUCTION

- The height of any new buildings should be similar to those of other buildings along the streetscape.
- The new construction shall be compatible with the width of the surrounding buildings.
- Materials should be compatible in quality, color, texture, finish and dimension to those commonly found in the historic district.

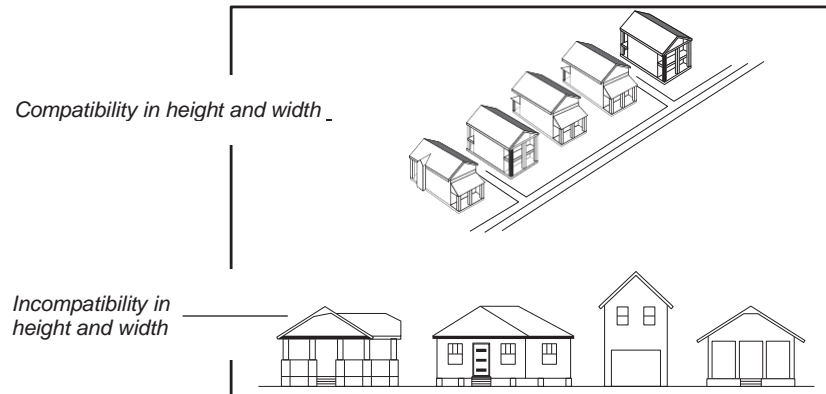

- Roof forms and pitch should be compatible with the surrounding buildings.

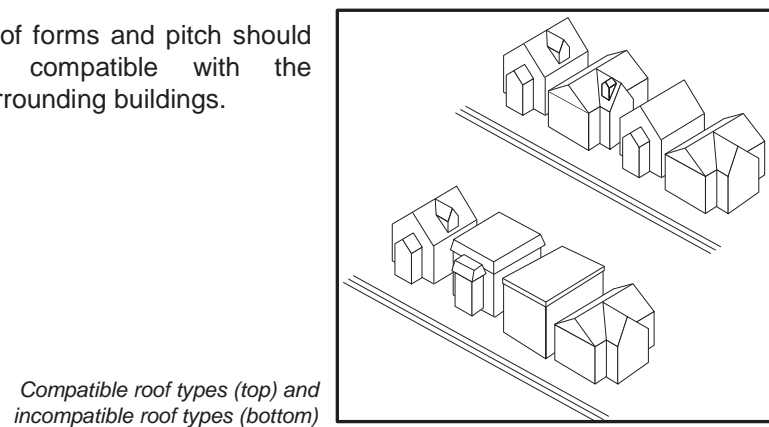

*Example of compatible building materials on a new residence in a historic district of Delray Beach*

- Window types and patterns, as well as their general placement, should be similar to surrounding buildings.
- The horizontal rhythms between the buildings also should be maintained.

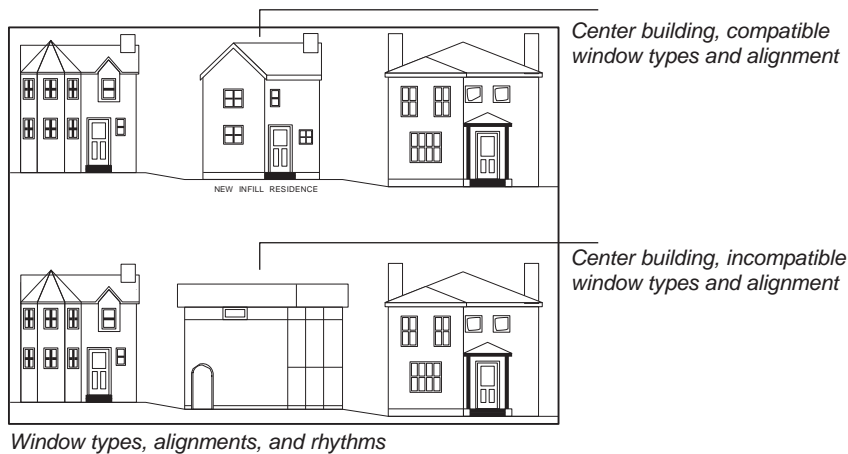

Setbacks, alignment, and orientation

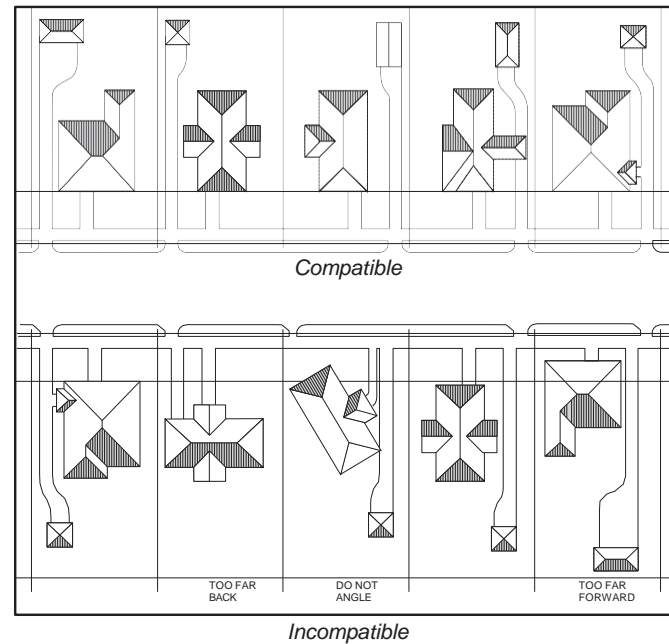

- The side and rear setbacks of the new construction must be met and aligned with the façades of the surrounding buildings.
- The orientation of the main elevation to the street also should be respected.
- The character of the massing should be compatible with the surrounding buildings. Massing means the geometric relationship of the building's component parts.
- Streetscape elements such as the divisions between stories, porch heights, and the alignment of windows and windowsills should be extended to the new construction.

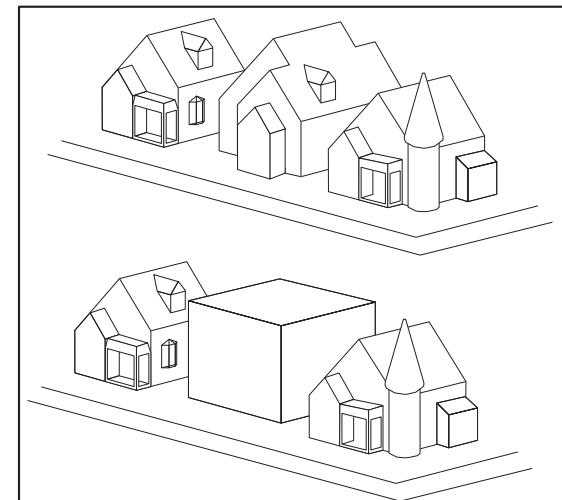

Compatible massing (top) and incompatible massing (bottom)



## SECTION VII. SPECIAL DESIGN CONSIDERATIONS

### PARKING

The setting of a property is important to our understanding of its use. **Setting** is defined as the physical environment of a property. The setting of a single-family residence includes open space, such as lawns, trees, berms, and associated landscaping, which should be respected as part of the district's overall context.

#### Recommended:

- Locate parking adjacent to the building but not beyond it, or in the rear.
- Screen parking that can be viewed from the public right-of-way with fencing, landscaping, or a combination of the two.
- Utilize existing alleys to provide vehicular access to buildings.
- Construct new curb cuts and streetside driveways only in areas where they are appropriate or existed historically.
- Use appropriate materials for driveways, such as concrete poured in ribbons.
- Avoid driveway expansions and circular drives for single-family uses; for residential conversions the expansions or reconfigurations may be necessary.



*Parking that can be viewed from the right-of-way should be screened with fencing and/or landscaping.*

### PAVING MATERIALS

- The maintenance of the original paving materials is encouraged.
- While, in most cases, brick was not used historically in Delray Beach, Old Chicago Brick may be used for driveway and walkway surfacing.
- Decorative pavers may be used for driveways, but will require administrative approval.



*Example of decorative pavers*

## ACCESSORY STRUCTURES

An accessory structure is defined as a structure that is located on the same lot as the principal building, but that is generally smaller and that is non-habitable. The most common example of an accessory structure is a detached garage that is associated with a residence. Other examples include, but are not limited to, tool sheds and pool equipment enclosures.

The accessory building may or may not be original to the principal building, and generally will not possess the same level of detail as the main building. However, they are still an important character-defining element and their preservation is encouraged. In evaluating the appropriate kind of rehabilitation treatment for an accessory structure/outbuilding, the age and quality of the structure should be assessed on a case-by-case basis.

### Recommended:

- Rehabilitate contributing accessory structures, where possible.
- Retain architectural features that convey the structure's original use.
- If the original use of the accessory structure is no longer required, the retention and adaptive use of the structure is encouraged.
- New accessory structures should compliment the principal building, and should be located to either the rear or the side of the principal building. Accessory structures should not block any portion of the front façade of the principle building.
- By their very nature, the role of accessory structures is subordinate to the principal building. Therefore, the accessory structure should not be modified, either structurally or with ornamental detail, to the degree that it assumes greater importance than the main building.



*An accessory structure is visible behind this Mediterranean Revival residence.*



*The most common example of an accessory structure is a detached garage that is associated with a residence, such as the structure at left.*



*An accessory structure behind a residential conversion*

## SIGNAGE

The sign code is contained in Delray Beach's Land Development Regulations, Section 4.6.7. The sign code regulates signage throughout the city, and should be consulted before applying for a sign permit.

### Types of Signs

Wall sign:

A flush-mounted sign affixed to a structure.



Projecting Sign:

A sign affixed to a structure that extends out at a right angle from the building.



Free-Standing Sign:

A sign not affixed to a structure, but free-standing, usually mounted on a pole, but that also may be a ground-mounted monument

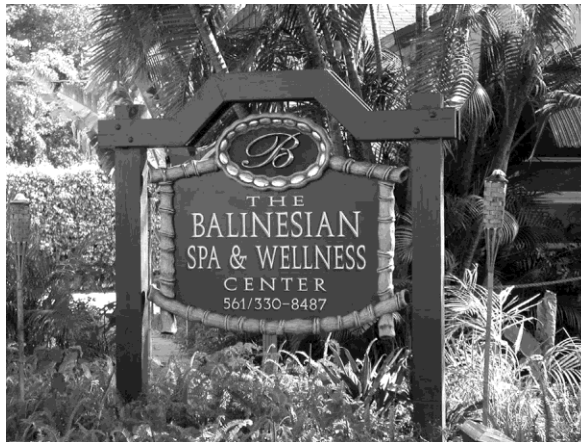

Under Canopy Sign:

A sign hung from a canopy, roof or walkway that may be rigid or may swing.





Awning Signs:  
Lettering that is applied to the valance of an awning.



#### Recommendations:

- Use materials and sign types that are based on historical precedent. For example, the use of neon tubing was common during the Art Deco period, but is inappropriate for buildings of another historical period.
- Place signage so significant architectural detail is not obscured.
- In commercial districts, the valance of an awning is often a visible and unobtrusive location for signage.
- Use indirect lighting when illuminating the sign.
- Avoid cabinet or box signs unless there is historical precedent.
- Ground-mounted signs are appropriate in cases of residential conversions.
- The scale of the signage should relate to the scale and detail of the historic building, and not overwhelm or call attention to the sign.
- The choice of typeface is a recommended way of conveying the period in which the building was constructed. Historic photographs of the period may be consulted to identify some common typestyles.

- The material of the sign need not be identical, but should be compatible with the construction materials of the building.
- For signs that are used in residential conversions, the application of the original materials, and sometimes details, is a recommended approach to sign design. For example, for a masonry building, a masonry monument sign may be an appropriate choice. If the building possesses a parapet detail, the signage may reflect that detail, tying the two together.



*Design elements on the sign compliments the Mission style parapet on the building*

#### Non-conforming Nostalgic Signs

*There are instances when the signage itself becomes historic.* For example, during the 1930s when Art Deco and Art Moderne styles were popular, signage became integral to the overall design. The Historic Preservation Board has the opportunity to exempt signs from the requirements and restrictions of the Sign Code when they are considered to have a historic or nostalgic appeal, and when they constitute artistic expression and not solely advertising.



## FIRE STAIRS

Life safety considerations take precedence over design matters; however, every effort should be made to achieve the most desirable solution when a historic property is affected.

When possible, fire stairs should not be visible from the street. Where this is not possible, the stairs should be constructed of the same building material or finished in a similar manner as the building to which they are attached.

To identify the least obtrusive locations, consider any non-historic additions, previously altered areas, and areas that have fewer design characteristics (typically the sides and rear).

## HANDICAP ACCESSIBILITY

The federal *Americans with Disabilities Act* (ADA) extends comprehensive civil rights to individuals with disabilities. For historic buildings that are open to the public, the effect of the ADA is to require retrofitting the structure so that adequate provision is made for its use. The ADA requirements do not extend to private residences, churches or private clubs. In Florida, the Florida Accessibility Code governs these issues.



Example of a building retrofitted for access

In considering the appropriate locations for ramps, elevators or lifts, attention should be given to those characteristics of the property that are most significant and include: materials, principal elevations, major architectural and/or landscape features and the principal public spaces.

When Congress enacted the *Americans with Disabilities Act*, it also provided alternative minimum requirements for “qualified” historic properties. A qualified historic property is defined as:

- A property listed or eligible for listing in the *National Register of Historic Places*; or
- A property that is designated under state or local law.

An owner of a historic property who seeks to use these alternative minimum requirements must first consult with the architectural division staff, who are responsible to the State Historic Preservation Officer (SHPO). If the SHPO determines that full compliance with the terms of the ADA would result in the destruction of the significant elements of a historic property, then the following alternative minimum requirements may be used:

- Provision of one accessible route from a site access point to an accessible entrance. Using a ramp with a 1:6 slope is permitted for a run of not more than two (2) feet.
- Provision of one accessible entrance. If it is not possible to make the public entrance accessible, then an alternative, unlocked entrance is acceptable. Directional signage at the primary entrance and a notification system at the accessible entrance must be provided.
- If toilets are provided, provision must be made for one that is accessible, and it may be unisex.

The chief building official also may make this decision.

## FENCES AND WALLS

Fencing, and garden and retaining walls add distinction to individual buildings and historic districts. They serve a practical purpose of forming property line boundaries, and to distinguish lines between the yard, sidewalk and street. Whenever possible, the original walls and/or fences should be preserved.

- For Colonial Revival and some vernacular designs, wooden pickets are a good choice for fencing.
- For Mediterranean Revival or Mission style buildings, simple masonry walls are appropriate.
- When masonry walls are finished with stucco, the texture and finish found on the main building should be repeated on the new walls.
- Chain-link fences clad in a green vinyl may only be used in rear yards, or where they are not visible from the street.



*Textured stucco on masonry walls should match the textured stucco on the main building.*



*Picket fencing is appropriate for this Frame Vernacular house.*

- New materials, some of them synthetic, may be approved on a case-by-case basis.

## SCREENING OF PARKING LOTS

The city of Delray Beach has enacted a Landscape Ordinance that establishes the minimum standards for the screening of parking lots. Fencing, walls or landscape buffers are appropriate solutions.



*Two examples of the use of landscaping to screen parking lots on commercial properties.*



## HURRICANE PREPAREDNESS FOR HISTORIC STRUCTURES

Owners of historic buildings are subject to a balancing act, in which they must weigh disaster readiness against the overall goals of protecting the character of the historic property itself. In evaluating the methods to secure a building from the effects of wind, water and impact from projectiles, the impact on the resource itself must be considered.

### Historic Buildings, Assets and Vulnerabilities

Historic buildings have definite advantages over much new construction, but they have specific vulnerabilities as well. Addressing those vulnerabilities will help them survive the worst of storms.

#### Assets

- Tongue and groove roof sheathing rather than plywood or particleboard;
- Heavier wood roof trusses/members rather than light pre-fabricated trusses; and
- Hammered nail connections rather than staple gun connectors.

#### Vulnerabilities

- Lack of lateral braces, ties and straps;
- Gravity connections to foundations;
- Overhanging and projecting eaves;
- Exposed porches and verandahs;
- Projecting awnings and canopies; and
- Exposed parapets and chimneys

### Window Shuttering Systems

More than any other single factor, maintaining the integrity of the windows is the primary defense against hurricanes. If a building's envelope is breached, winds enter the building and generate increased internal pressures for the roof and walls that can cause the structural integrity of the entire building to fail.

The choice of shuttering systems is dependent on a number of factors that include:

- The type of building to be shuttered (e.g., private home, institutional building, etc.);
- The visible impact of the shutter system to the character of the historic building;
- The style of the building;
- The expense of the system;
- Whether it meets building code requirements;
- Whether or not the system is designed for permanent year-round installation; and
- Whether or not the system can be installed in sufficient time and whether labor is available to mount the system when a hurricane threatens.



*Visible impact to the character of the historic building should be considered when selecting a shuttering system.*

As the technology improves, the numbers of options for shuttering increase. Currently, the most common types of systems for hurricane protection are:

Impact Resistant Glass • Accordion Shutters • Storm Panels • Perforated Metal Screens • Aluminum Awnings • Bahama Shutters • Colonial/ Board and Batten Shutters • Sill Track, Horizontal Rolling Shutters



Track installed year-round should be painted to match the building.

### Guidelines in the Choice of Shuttering Systems

- Window shutters that are removable are preferred.
- If the tracks are to be installed year-round, they should be painted to match the exterior surface.
- Accordion or roll-down shutters should only be considered when they are in locations not visible from the public right-of-way.

### Impact Resistant Glass

The Building Code does allow for the installation of impact-resistant glass in place of a shuttering system. The cost of this system should be evaluated against a shuttering system only in cases *where window replacements are required*. In any case, the new windows should resemble and reconfigure a historically appropriate type.

*There is no one prescribed method to shutter a historic building, the choice of system should be based on the preceding considerations, and in consultation with the Historic Preservation Planner.*

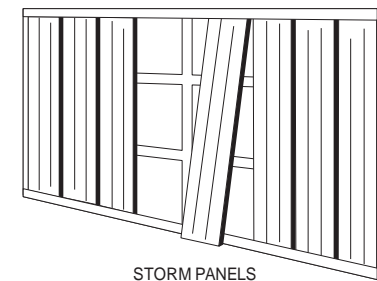
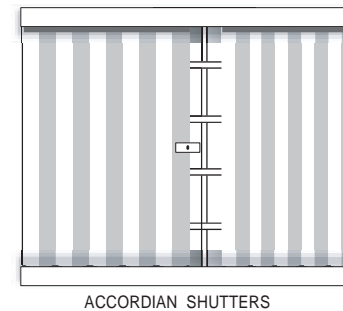
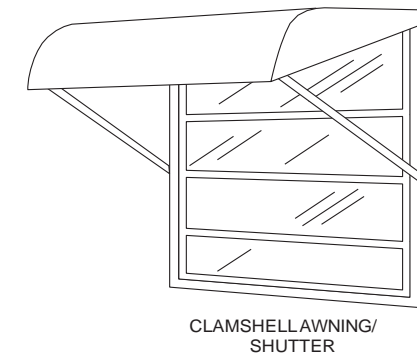
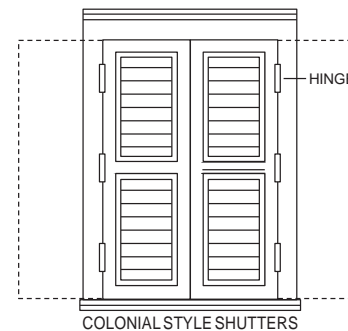
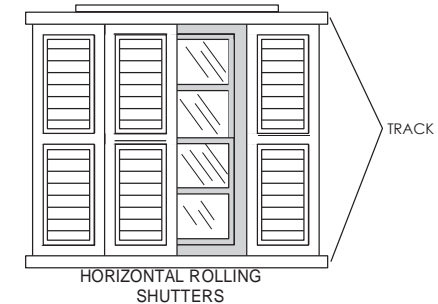
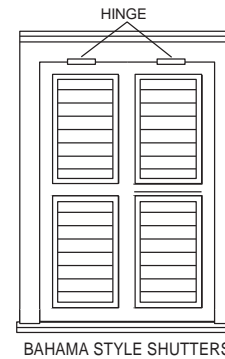



## **MECHANICAL SYSTEMS: HEATING, VENTILATION AND AIR CONDITIONING (HVAC), ELECTRICAL, PLUMBING, FIRE PROTECTION**

Mechanical upgrades are frequently a part of the rehabilitation process. With careful planning, damage from the installation of modern heating, ventilating and air conditioning systems can be avoided. Installation should be accomplished in the least obtrusive manner possible and in the most inconspicuous location.

Many historic buildings lend themselves to retrofitting as their raised foundations, generous attic spaces and existing chases and ductwork provide the space for the installation of new mechanical equipment. In most instances, systems such as boilers, compressors, generators and associated ductwork, wiring, and pipes, are functionally obsolete and will require replacement.

### **Rehabilitation Treatments**

#### ***Recommended:***

- Identify and retain features of early mechanical systems, such as vents, fans and grilles.
- Maintain mechanical, electrical and plumbing systems by ensuring their cyclical maintenance.
- Prevent accelerated deterioration of systems by providing adequate ventilation of attics, crawl spaces and ceilings so that moisture problems are minimized.
- Repair mechanical systems by augmenting or upgrading the existing system parts, such as installing new pipes and ducts, rewiring, or adding new compressors or boilers.
- Replace, either in-kind or with a compatible substitute, those visible features that are either severely deteriorated or are missing, when there are surviving prototypes such as ceiling fans and grilles.

- Install a new mechanical system that causes the least alteration of the building's floor plan, exterior elevations, and the historic building material.
- Install vertical runs of ducts, pipes and cables in closets, service rooms, chases and wall cavities.
- Install window air-conditioning units **ONLY** when all other viable alternatives have been explored. If used, window air-conditioning units should be installed so that the sash and frames are protected.

#### ***Not Recommended:***

- Removing or radically changing the features of mechanical systems that are important in defining the overall historic character of the building so that the character is diminished.
- Enclosing mechanical systems in areas that are not adequately ventilated so that deterioration of the system results.
- Replacing a mechanical system when it could be upgraded and retained.
- Installing a replacement feature that does not convey the same visual appearance.
- Cutting through features such as masonry walls in order to install air-conditioning units.
- Changing the appearance of a historic building by installing heating or air-conditioning units that destroy historic windows.

## **FLORIDA BUILDING CODE: ALTERNATIVE MATERIALS AND METHODS FOR SPECIAL HISTORIC BUILDINGS**

The Florida Building Code, the regulations used by building officials for the inspection and approval of any building permits, includes a section addressing the special authority of the Building Official over matters concerning retrofitting “qualified historic buildings” under Chapter of the 2001 Florida Building Code. Those alternatives must achieve equivalency with the requirements in the technical codes. The Building Official is guided by the *Secretary of the Interior’s Standards for Rehabilitation and Guidelines for Rehabilitating Historic Buildings* in his/her consideration of any alternatives.

A “qualified historic building” is either:

- Individually listed in the *National Register of Historic Places*;
- A contributing property in a *National Register*-listed historic district;
- Designated as a historic property under the provisions of the Delray Beach Historic Preservation Ordinance;
- A contributing property within a local historic district designated under the provisions of the Delray Beach Historic Preservation Ordinance; or,
- Determined eligible by the Florida State Historic Preservation Officer, either individually or as a contributing building or structure in a district, for listing in the *National Register of Historic Places*.

Should the need for alternative building materials or methods for retrofitting a historic property arise in relation to meeting the current building codes, contact the city’s Historic Preservation Planner for further information.



1913 photograph of Delray Elementary School



1980s photograph of Delray Elementary School taken prior to its conversion to a museum



Current Photograph of Delray Museum (formerly Delray Elementary School), part of the Old School Square Historic District



1989 photograph of Crest Theater, formerly Delray High School, now part of the Old School Square Historic District

## SECTION VIII: HISTORIC PRESERVATION INCENTIVES

### FEDERAL LEVEL: INVESTMENT TAX CREDIT (ITC)

The Investment Tax Credit is a dollar for dollar credit against income tax liability available when a historic building is rehabilitated. Only depreciable buildings (i.e., those used for income-producing purposes) are eligible for the credit. Qualified rehabilitation costs incurred during the construction period must exceed the greater of the adjusted basis of the property, or \$5,000. All expenditures made during the rehabilitation qualify for this 20% credit.

To be eligible for the ITC, a building must meet the definition of a “certified historic structure.” A certified historic structure may be:

- A building individually listed in the *National Register of Historic Places*; or
- A building located within a historic district listed in the *National Register of Historic Places*, provided that the building has historic significance to that particular district (i.e., that it has been classified as a contributing structure).

The rehabilitation of the building must be consistent with the Secretary of the Interior’s Standards for Rehabilitation. Approval of the federal ITC **does require review of the interior**. In particular, significant spatial interiors should not be altered, nor should original finishes, decorative detail, or any other distinctive interior features be removed during the rehabilitation work.

Florida’s Division of Historical Resources in Tallahassee first reviews an application for the investment tax credit, before it is sent on to the National Park Service reviewer in Washington, D.C. For questions or information about the ITC, contact the Architectural Services Section at the Division of Historical Resources.

### LOCAL LEVEL: AD VALOREM TAX INCENTIVES

In 1993, voters in Florida passed a constitutional amendment that allowed local governments to enact ordinances to provide property tax relief for historic properties. The resulting legislation is contained in Section 1A-38 of the *Florida Statutes*. Both the city of Delray Beach and Palm Beach County have established a property tax abatement program to encourage the preservation and rehabilitation of historically designated properties.

Ad valorem tax relief is available for both income-producing buildings and owner-occupied residences.

To be eligible for the local ad valorem tax incentive the building must be:

- Individually listed in the Delray Beach Local Register of Historic Places; or
- A contributing building and/or accessory structure within a historic district listed in the Delray Beach Local Register of Historic Places.

Buildings located within the boundaries of the Community Redevelopment Agency’s (CRA) taxing district are eligible for this program, provided that they have not participated in the CRA’s subsidized loan program.

The exemption is applicable to 100% of the assessed value of qualified real property improvements made to the property for a period of up to 10 years. For example, if the property is assessed by the Palm Beach County Property Appraiser’s office at \$100,000 and \$25,000 of qualifying rehabilitation improvements are made, the \$25,000 increase in assessment will not be taxable for 10 years. At the end of the 10 years, the property will be assessed at its full value, which will include the \$25,000 in rehabilitation costs.



To apply for the ad valorem property tax credit, Part I of the application must be completed and may be processed concurrently with an application for a Certificate of Appropriateness. The Historic Preservation Board will judge the appropriateness of the improvements and issue a recommendation for the tax relief.

Following completion of the construction, and after an inspection that insures the work was accomplished according to the plan, Part II of the application will be filed. Part II of the application must be submitted no later than November 1 of the year in which the tax abatement is requested.

The Historic Preservation Board will again meet to consider the final approval of the application. The Board's recommendation is then forwarded to the City Commission for action.

### **COMMUNITY REDEVELOPMENT AGENCY (CRA): HISTORIC FAÇADE EASEMENT**

The Community Redevelopment Agency has limited funding available to assist in rehabilitating commercial structures through its Historic Façade Easement Program. In order to qualify, the building must be designated in the Delray Beach Local Register of Historic Places.

In exchange for the grant, the CRA retains an easement over the building's façade, and must approve any architectural modifications to the exterior. For information concerning this program, contact the Delray Beach Community Redevelopment Agency at (561) 276-8640.

\*Color Change applications referred to the HPB will require a \$60 COA application fee; otherwise, color change applications do not require a fee.

\*\* Staff may refer any requests to the Historic Preservation Board (HPB) at the Planning and Zoning Department's discretion.

**Notes:**

- Requests not appropriately covered by this matrix may be referred to Staff or the Historic Preservation Board.
- Right of Way includes all public streets and alleys.
- Visibility refers setting on property, and does not consider existing landscaping at time of application.

**For more information on the City's Historic Preservation Program,  
please contact:**

**Historic Preservation Division**  
100 NW 1<sup>st</sup> Avenue  
Delray Beach, Florida 33444  
[pzmail@mydelraybeach.com](mailto:pzmail@mydelraybeach.com)  
561.243.7040

Matrix approved by the HPB October 20, 2010



**City of Delray Beach**  
**Historic Preservation Board**  
**Certificate of Appropriateness**  
**Review & Approval Matrix**

For all properties located within a designated historic district, & all individually designated sites listed on the Local Register of Historic Places.



Proposed Improvement	Contributing		Non-Contributing	
	Staff**	Board	Staff**	Board
<b>Accessory Structure</b> .....Rear of Principal Structure/Less than 200 Square Feet	X			
.....More than 200 Square Feet and/or exceeding one-story		X	X	X
<b>Additions</b> .....Not visible from ROW and 10% or less of existing square footage	X		X	
.....Visible from ROW and 10% or less of existing square footage		X	X	
.....All other additions		X		X
<b>Awnings</b> .....All Materials	X		X	
<b>Color Change*</b> .....Not involving other Matrix items	X		X	
<b>Deck or Patio</b> .....	X		X	
<b>Demolition</b> .....Non-historic addition: Up to 10% of building's total square footage	X		X	
.....All other demolition		X		X
<b>Doors-Front, Side, Garage, Etc.</b> .....Same Material, Size, Style, Details	X		X	
.....Change in Materials or Style		X	X	
.....Change in Openings Visible from ROW		X		X
.....Change in Openings Not visible from ROW	X		X	
<b>Driveways</b> .....New, Expansion of Existing, Material Change, etc.	X		X	
<b>Fences/Walls</b> .....New, Replacement of Existing – Same Height & Material, etc.	X		X	
<b>Landscaping</b> ..... Not Associated with Other Improvements	X		X	
.....Associated with Improvement(s) Requiring Board Review		X		X
<b>Mechanical Equipment (Generator, A/C, etc.)</b> .....New, Replacement, Relocation	X		X	
<b>New Construction (Principal Structure)</b> .....		X		X
<b>Porches</b> .....Modification of porch visible from ROW		X		X
.....Modification of porch not visible from ROW	X		X	
<b>Relocation of Structure</b> .....		X		X
<b>Roof</b> .....Same Material	X		X	
.....New Material		X	X	
<b>Shutters</b> .....Removable Hurricane Panels, Permanent Hurricane Shutters, Permanent Decorative Shutters, etc.	X		X	
<b>Signs</b> .....Replacement of Existing/No change in type, size, material, etc.	X		X	
.....New (including location, type, size, material, installation, posts, etc.)		X		X
<b>Swimming Pools</b> .....Visible from ROW		X		X
.....Not visible from ROW	X		X	
<b>Wall Finish – Exterior</b> .....Replacement with Same Material	X		X	
.....Replacement with New Material		X		X
<b>Windows</b> .....Same Material, Configuration, Type, Size, etc.	X		X	
.....Change in Material only	X		X	
.....Change in Type, Size, Configuration, etc.		X	X	

## APPENDIX B. THE SECRETARY OF THE INTERIOR'S STANDARDS FOR REHABILITATION

### The Secretary of the Interior's Standards for Rehabilitation

1. A property shall be used for its historic purpose or be placed in a new use that requires minimal change to the defining characteristics of the building and its site and environment.
2. The historic character of a property shall be retained and preserved. The removal of historic materials or alteration of features and spaces shall be avoided.
3. Each property shall be recognized as a physical record of its time, place, and use. Changes that create a false sense of historical development, such as adding conjectural features or architectural elements from other buildings shall not be undertaken.
4. Most properties change over time; those changes that have acquired historic significance in their own right shall be retained and preserved.
5. Distinctive features, finishes, and construction techniques, or examples of craftsmanship that characterize a property, shall be preserved.
6. Deteriorated historic features shall be repaired rather than replaced. Where the severity of deterioration requires replacement of a distinctive feature, the new feature shall match the old in design, color, texture and other qualities and, where possible, materials. Replacement of missing features shall be substantiated by documentary, physical or pictorial evidence.
7. Chemical or physical treatments, such as sandblasting, that cause damage to historic materials shall not be used. The surface cleaning of structures, if appropriate, shall be undertaken using the gentlest means possible.
8. Significant archeological resources affected by a project shall be protected and preserved. If such resources must be disturbed, mitigation measures shall be undertaken.
9. New additions, exterior alterations, or related new construction, shall not destroy historic materials that characterize the property. The new work shall be differentiated from the old and shall be compatible with the massing, size, scale and architectural features to protect the historic integrity of the property and its environment.
10. New additions and adjacent or related new construction shall be undertaken in such a manner that if removed in the future, the essential form and integrity of the historic property and its environment would be unimpaired.

Basic preservation principles and recommended rehabilitation treatments, that are consistent with these standards, begin in Section V of these Guidelines.







## APPENDIX C. A GLOSSARY OF FREQUENTLY USED TERMS

<b><u>TERM</u></b>	<b><u>DEFINITION</u></b>
<b>ACCESSORY BUILDING</b>	A building, structure, or use on the same lot with, and of a nature customarily incidental and subordinate to, the principal building or use. Examples would include detached garages or tool sheds.
<b>ALTERATION</b>	Any change affecting the exterior appearance of an existing structure or improvement by additions, reconstruction, remodeling, or maintenance; or any structural changes involving changes in form, texture, materials, or color; or any such changes in appearance in a designated historic site or historic interior; or, as applied to a building or structure, a change or rearrangement in the structural parts of the existing facilities, or an enlargement, whether by extending on a side or by increasing the height, or the moving from one location or position to another.
<b>ARCHITECTURAL FEATURES</b>	These include, but are not limited to, the exterior details of a building or structure, such as the type, style, or color of roofs, windows, doors, and appurtenances. Architectural features will include interior architectural features where the interior has been given historic designation.
<b>ASSOCIATION</b>	Association is the direct link between an important historic event or person and a historic property.
<b>BUILDING</b>	A walled and roofed building that is principally aboveground, as well as a manufactured home or anything constructed or erected with a fixed location on the ground, or attached to something having a fixed location on the ground. The term is used to distinguish from constructions made for purposes other than creating human shelter.
<b>CERTIFICATE OF APPROPRIATENESS</b>	A written document allowing specified alterations, demolition, construction, or other work to a designated historic site, or for a building or structure within a designated historic district.
<b>CONSERVATION DISTRICTS</b>	A conservation district is applied to a neighborhood that: does not meet the architectural or density requirements of a traditional historic district; is a distinctive neighborhood that is not yet 50 years old; or is a low- to moderate-income neighborhood. It is intended to provide a land use and zoning tool that will promote compatible development by regulating new construction, and major additions/alterations to existing buildings. The concentration is often more on massing and scale of buildings in the district.
<b>CONTRIBUTING BUILDING</b>	A building contributing to the historic significance of a district which, by virtue of its location, design, setting, materials, workmanship, or association with local historic events or personalities, lends to the district's sense of time and place within the context of the intent of historic preservation. Typically, these resources are more than 50 years old.



*Accessory Building*

<b>EAVE</b>	The projecting overhang at the lower edge of a roof.	
<b>FABRIC</b>	The physical material of a building.	
<b>FAÇADE</b>	That portion of any exterior elevation of a building extending from grade to the top of the parapet wall or eaves and the entire width of the building elevation.	<i>Eave</i>
<b>FEELING</b>	The quality of integrity through which a historic property evokes the aesthetic or historic sense of past time and place.	
<b>FENESTRATION</b>	The design and placement of windows and doors (openings).	
<b>HISTORIC DISTRICT</b>	A geographically defined area that possesses a significant concentration, linkage or continuity of sites, buildings, structures or objects that are united by their history, function, or development. Any historic district may have within its area non-historic buildings or other structures that contribute to the overall visual character of the district.	
<b>HISTORIC SITE</b>	Any site, building, structure, feature, or improvement that has been designated by the City Commission as a historic site.	
<b>HISTORIC SITES SURVEY</b>	A comprehensive survey designated to identify, research, and document building sites and structures of any historic, cultural, architectural, or landmark importance in the city. The board may compile this survey in cooperation with state and local public and non-profit historic preservation organizations to prevent a duplication of effort	
<b>INFILL</b>	Descriptive of buildings that have been designed and built to replace missing structures or otherwise fill gaps in the streetscape.	
<b>IN-KIND</b>	In-kind means that the replacement element is exactly the same as the original element. For example, wood casement windows would be replaced with wood casement windows that are identical to the originals.	
<b>INTEGRITY</b>	Historic integrity refers to the authenticity of a property, as evidenced by the survival of its physical characteristics. Historic integrity is the composite of these seven qualities: location, design, setting, materials, workmanship, feeling and association.	
<b>IMPROVEMENT</b>	Any physical change or betterment of a historic property.	
<b>LOCAL REGISTER OF HISTORIC PLACES</b>	A listing and a means by which to identify, classify, and recognize various archaeological sites, buildings, structures, improvements, districts, and appurtenances as historically and/or architecturally significant.	
<b>MASSING</b>	The arrangement of various geometric forms of a building into a whole.	
<b>NATIONAL REGISTER OF HISTORIC PLACES</b>	The official list of districts, sites, buildings, structures, and objects significant in American history, architecture, archaeology, engineering and culture. These contribute to an understanding of the historical and cultural foundations of the nation.	



**NON-CONTRIBUTING BUILDING**

A building within a historic district which does not add to a historic district’s sense of time and place and historical development; or a building where the location, design, setting, materials, workmanship, and association have been so changed or have so deteriorated, that the overall integrity of the building has been irretrievably lost. Typically, these resources are less than 50 years old.

**ORDINARY MAINTENANCE OR REPAIR**

Any work for which a building permit is not required by law, where the purpose and effect of such work is to correct any physical deterioration or damage of an improvement or any part thereof, by restoring it, as nearly as practical, to its appearance prior to the occurrence of such deterioration or damage.

**PARAPET**

A false front or wall extension above the roof line.



*Parapet*

**PILASTER**



*Pilasters surrounding a door*

Architectural ornament that imitates columns but is flush with the wall surface and stands out in relief. In classical architecture, it follows the height and width of related columns, with similar base and capital.

**PRESERVATION**

The process of applying measures that will sustain the existing form, integrity, and material of a building or structure. This may include initial stabilization of the building or its features and ongoing maintenance.

**REHABILITATION**

The process of returning a building to a state of usefulness through repair or alteration which allows for a contemporary use while preserving those features that are historically or architecturally significant.

**RESTORATION**

The process of accurately recovering the form and details of a building and its setting as it appeared at an earlier time. This can include the removal of later added features or the replacement of missing earlier features.

**RIDGE**

The highest point of a roof, running from end to end.

**RIGHT-OF-WAY**

A strip of land dedicated or deeded to the perpetual use of the public.

**SCALE**

The proportions of a building in relation to its surroundings, particularly other buildings in the surrounding context.

**SETTING**

The physical environment of a historic property. It involves how, not just where, the property is situated and its relationship to surrounding features and open space.

**SHUTTER DOG**

Refers to the decorative hardware that is used to keep window shutters in an open position.

**SOFFIT**

The finished underside of a lintel, arch or other spanning member, usually overhead.

**SOLIDS AND VOIDS**

A concept that can apply to both streetscapes and elevations, but is most frequently used to evaluate the relationship between infill (new construction) and the façades of historic structures within a historic district. Solids refer to the wall mass, while voids may represent windows, doors, open porches, porte cochères, or other elements of a building that open up the wall mass.



*Shutter dog*

**STABILIZATION**

The act or process of applying measures designed to reestablish structural stability, while maintaining the essential form as it exists at present.

**STREETSCAPE**

A view or vista of a specific street, the distinguishing characteristics of which are created by the width of the design of street furniture, the potential use of the street and sidewalks, their paving materials and color, the plant materials such as trees and shrubs, and the setback, mass, proportion and scale of those buildings which enclose the street.

**UNDUE ECONOMIC  
HARDSHIP**

An exceptional financial burden that might otherwise amount to the taking of property without just compensation, or failure to achieve a reasonable economic return.

**WINDOW TERMS AND  
TYPES**

***Awning window:*** A window that is comprised of a series of top hinged horizontal sashes one above the other. The bottom edges swing outward, operated by one opener.



*Awning windows*

***Casement window:*** A window sash that swings open along its entire length, usually on hinges. (see illustration, right)

***Double-hung sash window:*** A window having two vertically sliding sashes, each closing a different part of the window. The weight of each sash is counterbalanced for ease of opening and closing. (see illustration, p. 75)

***Frame:*** The fixed non-operable frame of the window that receives and holds the sash or casement and its hardware. (see illustration, p. 75)

***Glazing:*** Setting glass into an opening.

***Jalousie:*** A collapsible window or door blind of moveable slats.

***Light:*** A pane of glass.

***Mullion:*** A secondary framing member that holds panes within the window. Used interchangeably with muntin.

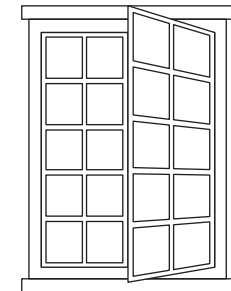

*Casement window*



*Metal louver windows*

## WINDOW TERMS AND TYPES (CONT.)

**Muntin:** A secondary framing member that holds panes within the window. Used interchangeably with mullion.

**Rail:** A horizontal piece in the framework of a window sash.

**Sash:** Any framework of window, which may be operable or fixed; may slide in a vertical plane, as in a double-hung window; or may be pivoted, as in a casement window.

**Single-Hung Sash Window:** A vertically sliding window in which one of the sashes (usually the lower) may be opened and the other sash is fixed.

**Stile:** One of the vertical structural members of a frame, at the outer edge of a window sash.

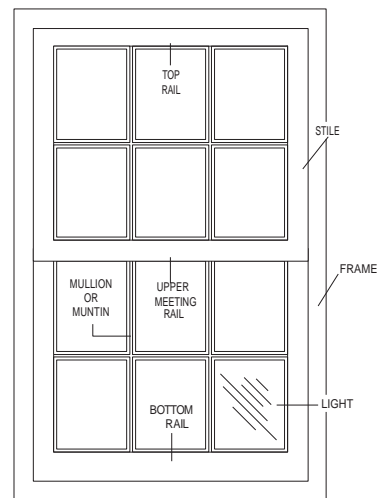

*Double-hung sash window and frame*



## APPENDIX D. ADDITIONAL RESOURCES, STATE AND FEDERAL AGENCIES, ORGANIZATIONS

Organization	Address	Website/E-mail/Tel. #	Description
Florida Division of Historical Resources (FDHR)/Florida SHPO	R.A. Gray Building 500 South Bronough Street Tallahassee, FL 33299-0250	<a href="http://www.dos.state.fl.us/dhr/index.html">www.dos.state.fl.us/dhr/index.html</a> <a href="mailto:fldhr@mail.dos.state.fl.us">fldhr@mail.dos.state.fl.us</a> 850-245-6300	Provides information concerning statewide historic preservation topics, including the <i>National Register</i> , tax incentives and research materials.
Advisory Council on Historic Preservation	1100 Pennsylvania Ave. NW Suite 809 Washington, D.C. 20004	<a href="http://www.achp.gov">www.achp.gov</a> <a href="mailto:achp@achp.gov">achp@achp.gov</a> 202-606-8503	Provides information on the National Historic Preservation Program, educational programs and publications.
Florida Trust for Historic Preservation	P.O. Box 11206 Tallahassee, FL 32302	<a href="http://www.floridatrust.org">www.floridatrust.org</a> <a href="mailto:information@floridatrust.org">information@floridatrust.org</a> 850-224-8128	Provides information on preservation publications, workshops, conferences and contacts throughout Florida.
National Trust for Historic Preservation	1785 Massachusetts Ave. NW Washington, DC 20036-2117	<a href="http://www.nthp.org">www.nthp.org</a> 202-588-6000	Provides information on leadership, education, and advocacy regarding historic preservation. This website features a number of educational programs.
The American Association for State & Local History	1717 Church Street Nashville, TN 37203-2991	<a href="http://www.aaslh.org/">www.aaslh.org/</a> <a href="mailto:history@aaslh.org">history@aaslh.org</a> 615-320-3203	This organization provides leadership and support for those who preserve and interpret state and local history.
National Alliance of Preservation Commissions	Post Office Box 1605 Athens, GA 30603	<a href="http://www.arches.uga.edu/~napc/">www.arches.uga.edu/~napc/</a> <a href="mailto:napc@uga.edu">napc@uga.edu</a> 706-542-4731	This organization provides contacts, and publications for municipal Historic Preservation Boards throughout the country.
National Center for Preservation Technology and Training	645 College Avenue Natchitoches, LA 71457	<a href="http://www.ncptt.nps.gov">www.ncptt.nps.gov</a> <a href="mailto:ncptt@ncptt.nps.gov">ncptt@ncptt.nps.gov</a> 318-356-7444	This Web site has information on training, education, and conservation issues, and is also a clearinghouse for other online resources.
National Conference of State Historic Preservation Officers	Suite 342, Hall of the States 444 North Capitol Street NW Washington, D.C. 20001-7572	<a href="http://www.ncshpo.org/">www.ncshpo.org/</a> 202-624-5465	Provides information on this professional association of state government officials who carry out the National Historic Preservation Program. A list of all SHPOs is included on the Web site, as well as an online database of state legislation dealing with historic preservation.



Organization	Address	Website/E-mail/Tel. #	Description
National Park Service	1849 C Street NW Washington, D.C. 20240	<a href="http://www.nps.gov">www.nps.gov</a> 202-208-6843	Provides information on the National Park system, as well as a great deal of information regarding the historic resources and programs that the NPS regulates. Preservation briefs and the National Register Information System are found through this Web site.
Preservation Action (Legislation Information)	1054 31 <sup>st</sup> Street NW Suite 526 Washington, D.C. 20007	<a href="http://www.preservationaction.org">www.preservationaction.org</a> <a href="mailto:mail@preservationaction.org">mail@preservationaction.org</a> 202-298-6180	This Web site includes outreach and advocacy programs and lists the current legislation related to historic preservation that is being considered.
National Trust, Southern Regional Office	456 King Street Charleston, SC 29403	<a href="http://www.nthp.org/about_the_trust/regional/southern.html">www.nthp.org/about_the_trust/regional/southern.html</a> <a href="mailto:soro@nthp.org">soro@nthp.org</a> 843-722-8552	This arm of the National Trust is assigned to the southern region of the U.S. They assist in regional preservation issues or provide information.
Preservation Directory	1507 SW 17 <sup>th</sup> Avenue Portland, OR 97201	<a href="http://www.preservationdirectory.com">www.preservationdirectory.com</a> <a href="mailto:info@preservationdirectory.com">info@preservationdirectory.com</a> 503-223-4939	This Web site provides research and resource tools for areas such as historic preservation, cultural resource management. This site also includes a comprehensive source of federal preservation laws.
PreserveNet		<a href="http://www.preservenet.cornell.edu">www.preservenet.cornell.edu</a> <a href="mailto:preservenet@cornell.edu">preservenet@cornell.edu</a>	This Web site provides research and resource tools for areas such as historic preservation, cultural resource management, and historical organizations and services.





*Delray Beach*  
HISTORIC  
PRESERVATION DESIGN  
GUIDELINES Adopted  
2003 – Revised 2018